



/// USER MANUAL
RXF FREERIDE 125 / FREERIDE 140 / FREERIDE 150
FREERIDE S 190





READ THIS MANUAL CAREFULLY BEFORE OPERATING THIS VEHICLE. THIS MANUAL SHOULD STAY WITH THIS VEHICLE IF IT IS SOLD.

EC Declaration of Conformity
conforming to Directive 2006/42/EC

We, Zhejiang Apollo Motorcycle Manufacturer Co. Ltd
Jinyan hill Industrial Area, Quanxi Town, Wuyi City,
Zhejiang Province, China
declare in sole responsibility, that the product

RXF FREERIDE 125 (AGB125MKA37RXF8)

(Mark, Model)

to which this declaration applies, conforms to the essential health and safety requirements of Directive 2006/42/EC

(if applicable)
and to the other relevant Directives of EEC

2014/30/EU

(Title and/or number and date of issue of the other directives of EEC)

(if applicable)
To effect correct application of the essential health and safety requirements stated in the Directives of EEC, the following-standards and/or technical specifications were consulted:

EN16029

(Title and/or number and date of issue of standard and/or specifications)

Signature

Ying Er
General Manager.

Date of Issue

01/01/2018

EC Declaration of Conformity
conforming to Directive 2006/42/EC

We, Zhejiang Apollo Motorcycle Manufacturer Co. Ltd
Jinyan hill Industrial Area, Quanxi Town, Wuyi City,
Zhejiang Province, China
declare in sole responsibility, that the product

RXF FREERIDE 140 (AGB140MKA37RXF8)

(Mark, Model)

to which this declaration applies, conforms to the essential health and safety requirements of Directive 2006/42/EC

(if applicable)
and to the other relevant Directives of EEC

2014/30/EU

(Title and/or number and date of issue of the other directives of EEC)

(if applicable)
To effect correct application of the essential health and safety requirements stated in the Directives of EEC, the following-standards and/or technical specifications were consulted:

EN16029

(Title and/or number and date of issue of standard and/or specifications)

Signature

Ying Er
General Manager.

Date of Issue

01/01/2018

EC Declaration of Conformity
conforming to Directive 2006/42/EC

We, Zhejiang Apollo Motorcycle Manufacturer Co. Ltd
Jinyan hill Industrial Area, Quanxi Town, Wuyi City,
Zhejiang Province, China
declare in sole responsibility, that the product

RXF FREERIDE 150 (AGB150MK037RXF8)

(Mark, Model)

to which this declaration applies, conforms to the essential health and safety requirements of Directive 2006/42/EC

(if applicable)
and to the other relevant Directives of EEC

2014/30/EU

(Title and/or number and date of issue of the other directives of EEC)

(if applicable)
To effect correct application of the essential health and safety requirements stated in the Directives of EEC, the following-standards and/or technical specifications were consulted:

EN16029

(Title and/or number and date of issue of standard and/or specifications)

Signature

Ying Er
General Manager.

Date of Issue

01/01/2018

EC Declaration of Conformity
conforming to Directive 2006/42/EC

We, Zhejiang Apollo Motorcycle Manufacturer Co. Ltd
Jinyan hill Industrial Area, Quanxi Town, Wuyi City,
Zhejiang Province, China
declare in sole responsibility, that the product

FREERIDE S 190 (AGB190MK037RXF8)

(Mark, Model)

to which this declaration applies, conforms to the essential health and safety requirements of Directive 2006/42/EC

(if applicable)
and to the other relevant Directives of EEC

2014/30/EU

(Title and/or number and date of issue of the other directives of EEC)

(if applicable)
To effect correct application of the essential health and safety requirements stated in the Directives of EEC, the following-standards and/or technical specifications were consulted:

EN16029

(Title and/or number and date of issue of standard and/or specifications)

Signature

Ying Er
General Manager.

Date of Issue

01/01/2018

// INTRODUCTION

Congratulations on your purchase of the Apollo RXF (FREERIDE 125 / FREERIDE 140 / FREERIDE 150 / FREERIDE S 190). This model is the result of Apollo's vast experience in the production of fine sporting, touring, and pacesetter racing machines. It represents the high degree of craftsmanship and reliability that have made Apollo a leader in these fields.

This manual will give you an understanding of the operation, inspection, and basic maintenance of this motorcycle. If you have any questions concerning the operation or maintenance of your motorcycle, please consult an Apollo dealer.

The design and manufacture of this Apollo motorcycle fully comply with the emissions standards for clean air applicable at the date of manufacture. Apollo has met these standards without reducing the performance or economy of operation of the motorcycle. To maintain these high standards, it is important that you and your Apollo dealer pay close attention to the recommended maintenance schedules and operating instructions contained within this manual.

Apollo continually seeks advancements in product design and quality. Therefore, while this manual contains the most current product information available at the time of printing, there may be minor discrepancies between your motorcycle and this manual. If there is any question concerning this manual, please consult an Apollo dealer.







Please read this manual carefully and completely before operating this motorcycle.



This motorcycle is designed and manufactured for off-road use only. It is illegal to operate this motorcycle on any public street, road or highway. Such use is prohibited by law. This motorcycle complies with almost all state off-highway noise level and spark arrester laws and regulations. Please check your local riding laws and regulations before operating this motorcycle.

AN IMPORTANT SAFETY MESSAGE:

-  Read this manual carefully and completely before operating this motorcycle. Make sure you understand all instructions.
-  Pay close attention to the warning and notice labels on the motorcycle.
-  Never operate a motorcycle without proper training or instruction.
-  Weight of the rider should not exceed 100 kg (220 lb).

AN IMPORTANT NOTE TO PARENTS:

This motorcycle is not a toy. Before you let your child ride this motorcycle, you should understand the instructions and warnings in this Owner's Manual. Then be sure your child understands and will follow them. Children differ in skills, physical abilities, and judgment. Some children may not be able to operate a motorcycle safely. Parents should supervise their child's use of the motorcycle at all times. Parents should permit continued use only if they determine that the child has the ability to operate the motorcycle safely.

Your motorcycle is equipped with an adjustable speed limiter and a power reduction plate. Apollo recommends that all beginners start off with the speed limiter adjusting screw turned in and the power reduction plate installed in the exhaust manifold to limit the power available while they learn. The limiter screw may be gradually turned out to increase maximum speed as the beginner becomes more familiar with operating the motorcycle. Parents should decide when to adjust the motorcycle for more power as their youngster's riding skills improve.

RIDER SHOULD DO :

- 👤 Obtain thorough instructions from a competent source on all aspects of motorcycle operation.
- 👤 Observe the warnings and maintenance requirements in this Owner's Manual.
- 👤 Obtain qualified training in safe and proper riding techniques.
- 👤 Obtain professional technical service as indicated in this Owner's Manual and/or when made necessary by mechanical conditions.

// REGISTRATION

Congratulations on your decision to purchase a Apollo motorcycle. You are now the owner of a state-of-the-art sports motorcycle that will give you and your child enormous pleasure if you service and maintain it accordingly.

We hope you enjoy your new vehicle!

Enter the serial numbers of your vehicle below.

Chassis number  p. 26

Engine number  p. 25

Dealer's stamp

The Owner's Manual contained the latest information for this model series at the time of going to print. Minor differences due to developments in design cannot be ruled out completely.

All specifications are non-binding. Apollo specifically reserves the right to modify or delete technical specifications, prices, colors, forms, materials, services, designs, equipment, etc., without prior notice and without specifying reasons, to adapt these to local conditions, as well as to stop production of a particular model without prior notice. APOLLO accepts no liability for delivery options, deviations from illustrations and descriptions, misprints, and other errors. The models portrayed partly contain special equipment that does not belong to the regular scope of supply.









© 2018 APOLLO, CHINA.

All rights reserved

Reproduction, even in part, as well as copying of all kinds, is permitted only with the express written permission of the copyright owner.

Important information about the manual

Particularly important information is distinguished in this manual by the following notations:

	This is the safety alert symbol. It is used to alert you to potential personal injury hazards. Obey all safety messages that follow this symbol to avoid possible injury or death.
	A WARNING indicates a hazardous situation which, if not avoided, could result in death or serious injury.
	A WARNING indicates a hazardous situation which, if not avoided, could result in death or serious injury.
	Indicates a danger to the environment.
	All work marked with this symbol requires specialist knowledge and technical understanding. In the interest of the safety of your child, have these jobs performed in an authorized Apollo workshop. There, your motorcycle will be optimally cared for by specially trained experts using the specialist tools required.
	Indicates a page reference (more information is provided on the specified page).
	Indicates information with more details or tips.
	Indicates the result of a testing step.

The product and specifications are subject to change without notice.

// TABLE OF CONTENTS

1. LOCATION OF IMPORTANT LABELS (p.10)

- 1.1 CANADA (p.10)
- 1.2 EUROPE (p.12)
- 1.3 OCEANIA AND SOUTH AFRICA (p.17)

2. SAFETY ADVICE (p.19)

- 2.1 SE DEFINITION - INTENDED USE (p.19)
- 2.2 SAFETY ADVICE (p.19)
- 2.3 BE A RESPONSIBLE OWNER (p.19)
- 2.4 SAFE RIDING (p.20)
- 2.5 PROTECTIVE APPAREL (p.21)
- 2.6 AVOID CARBON MONOXIDE POISONING (p.21)
- 2.7 LOADING (p.22)
- 2.8 GENUINE APOLLO ACCESSORIES (p.22)
- 2.9 AFTERMARKET PARTS, ACCESSORIES, AND MODIFICATIONS (p.22)
- 2.10 AFTERMARKET TIRES AND RIMS (p.23)
- 2.11 TRANSPORTING THE MOTORCYCLE (p.23)
- 2.12 WORK RULES (p.24)
- 2.13 ENVIRONMENT (p.24)

3. VIEW OF VEHICLE (p.25)

- 3.1 VIEW OF VEHICLE, FRONT LEFT (p.25)
- 3.2 VIEW OF VEHICLE, FRONT RIGHT (p.26)

4. CONTROLS (p.27)

- 4.1 CLUTCH LEVER (p.27)
- 4.2 HAND BRAKE LEVER (p.27)
- 4.3 THROTTLE GRIP (p.27)
- 4.4 KILL SWITCH (p.27)
- 4.5 ELECTRIC STARTER BUTTON (ONLY FOR ELECTRIC STAR) (p.28)
- 4.6 SERVICE HOUR COUNTER (p.28)
- 4.7 ON/OFF SWITCH (p.28)
- 4.8 OPENING FILLER CAP (p.29)
- 4.9 CLOSING FILLER CAP (p.29)
- 4.10 FUEL TAP (p.30)
- 4.11 CHOKE (p.30)
- 4.12 KICK STARTER (p.30)
- 4.13 FOOT BRAKE LEVER (p.31)
- 4.14 SHIFT LEVER (p.31)
- 4.15 SIDE STAND (p.31)

5. PREPARING FOR USE (p.32)

- 5.1 FIRST USE (p.32)
- 5.2 RUNNING IN THE ENGINE (p.34)

6. RIDING INSTRUCTIONS (p.36)

- 6.1 CHECKS AND MAINTENANCE WORK WHEN PREPARING FOR USE (p.36)
- 6.2 STARTING (p.36)
- 6.3 ELECTRIC STARTING (ELECTRIC START ONLY) (p.37)
- 6.4 RIDING (p.38)
- 6.5 BRAKING (p.38)
- 6.6 STOPPING (p.39)
- 6.7 TRANSPORT (p.39)
- 6.8 REFUELING (p.40)

7. MAINTENANCE (p.41)

- 7.1 INFORMATIONS (p.41)
- 7.2 OWNER'S TOOL KIT (p.41)
- 7.3 PERIODIC MAINTENANCE AND ADJUSTMENT (p.42)

8. SUSPENSIONS (p.44)

- 8.1 INFORMATIONS (p.44)
- 8.2 CHANGING THE SPRING PRELOADING OF THE

SHOCK ABSORBER (p.44)

8.3 VOLT VFORCE SHOCK ABSORBER (ELITE MODEL ONLY) (p.45)

8.4 VOLT VTRAAK SHOCK ABSORBER (FROM ELITE S MODEL ONLY) (p.45)

8.5 VOLT VTRAAK FRONT FORK (FROM ELITE MODEL) (p.47)

8.6 BREATHER PLUG FRONT FORK (p.47)

8.7 CLEANING THE DUST SLEEVES OF THE TELESCOPIC FORK (p.48)

8.8 HOW TO CHANGE THE HANDLEBAR POSITION (p.48)

9. BRAKE SYSTEM (p.49)

9.1 CHECKING THE BRAKE DISCS (p.49)

9.2 CHECKING THE BRAKE FLUID LEVEL OF THE FRONT AND REAR BRAKES (p.49)

9.3 ADDING FRONT AND REAR BRAKE FLUID (p.50)

9.4 CHECKING THE FRONT AND REAR BRAKE LININGS (p.52)

9.5 CHANGING THE FRONT AND REAR BRAKE LININGS (p.52)

9.6 ADJUSTING THE BASIC POSITION OF THE FOOT BRAKE LEVER (p.53)

10. WHEELS, TIRES (p.54)

10.1 REMOVING THE FRONT WHEEL (p.54)

10.2 INSTALLING THE FRONT WHEEL (p.54)

10.3 REMOVING THE REAR WHEEL (p.55)

10.4 INSTALLING THE REAR WHEEL (p.56)

10.5 CHECKING THE TIRE CONDITION (p.56)

10.6 CHECKING THE TIRE AIR PRESSURE (p.57)

10.7 CHECKING SPOKE TENSION (p.57)

11. SERVICE WORK ON THE CHASSIS (p.58)

11.1 CLEANING THE DUST BOOTS OF THE FORK LEGS (p.58)

11.2 REMOVING THE FORK PROTECTOR (p.58)

11.3 INSTALLING THE FORK PROTECTOR (p.59)

11.4 REMOVING THE FORK LEGS (p.59)

11.5 INSTALLING THE FORK LEGS (p.60)

11.6 REMOVING THE LOWER TRIPLE CLAMP (p.61)

11.7 INSTALLING THE LOWER TRIPLE CLAMP (p.61)

11.8 CHECKING PLAY OF STEERING HEAD BEARING (p.63)

11.9 ADJUSTING THE STEERING HEAD BEARING PLAY (p.64)

11.10 GREASING THE STEERING HEAD BEARING (p.64)

11.11 REMOVING THE START NUMBER PLATE (p.64)

11.12 INSTALLING THE START NUMBER PLATE (p.65)

11.13 DISMOUNTING THE FRONT FENDER (p.65)

11.14 INSTALLING THE FRONT FENDER (p.65)

11.15 REMOVING THE SHOCK ABSORBER (p.66)

11.16 INSTALLING THE SHOCK ABSORBER (p.66)

11.17 REMOVING THE SEAT (p.67)

11.18 MOUNTING THE SEAT (p.67)

11.19 REMOVING THE AIR FILTER (p.68)

// **TABLE OF CONTENTS** (2)

- 11.25 ADJUSTING THE CHAIN TENSION (p.70)
- 11.26 CHECKING THE CHAIN, REAR SPROCKET, ENGINE SPROCKET, AND CHAIN GUIDE (p.71)
- 11.27 CHECKING THE FRAME (p.73)
- 11.28 CHECKING THE SWINGARM (p.73)
- 11.29 CHECKING THE THROTTLE CABLE ROUTING (p.73)
- 11.30 CHECKING THE RUBBER GRIP (p.74)
- 11.31 ADDITIONALLY SECURING THE RUBBER GRIP (p.74)

12. ENGINE (p.75)

- 12.1 CHECKING THE PLAY OF THE THROTTLE CABLE (p.75)
- 12.2 ADJUSTING THE PLAY IN THE THROTTLE CABLE (p.75)
- 12.3 CARBURETOR - IDLE (p.76)
- 12.4 CARBURETOR - ADJUSTING IDLE SPEED (p.76)
- 12.5 CHECKING THE BASIC POSITION OF THE SHIFT LEVER (p.77)
- 12.6 ADJUSTING THE BASIC POSITION OF THE SHIFT LEVER (p.77)
- 12.7 CHECKING THE ENGINE OIL LEVEL (p.78)
- 12.8 CHANGING THE ENGINE OIL AND OIL FILTER, CLEANING THE OIL SCREENS (p.78)
- 12.9 ADDING ENGINE OIL (p.80)

13. ELECTRICAL SYSTEM (p.81)

- 13.1 REMOVING THE BATTERY (p.81)
- 13.2 INSTALLING THE BATTERY (p.81)

14. CLEANING, CARE (p.82)

- 14.1 CLEANING THE MOTORCYCLE (p.82)

15. STORAGE (p.83)

- 15.1 BIKE STORAGE (p.83)

16. TROUBLESHOOTING (p.84)

17. TECHNICAL DATA (p.85)

- 17.1 ENGINE (p.85)
 - 17.1.1 FREERIDE 125 (p.85)
 - 17.1.2 FREERIDE 140 (p.85)
 - 17.1.3 FREERIDE 150 (p.86)
 - 17.1.6 FREERIDE S 190 (p.86)
- 17.2 CARBURATOR SETTINGS (p.87)
 - 17.2.1 FREERIDE 125 (p.87)
 - 17.2.2 FREERIDE 140 (p.87)
 - 17.2.3 FREERIDE 150 (p.87)
 - 17.2.4 FREERIDE S 190 (p.87)
- 17.3 CAPACITIES (p.88)
 - 17.3.1 ENGINE OIL (p.88)
 - 17.3.2 FUEL (p.88)
- 17.4 CHASSIS (p.88)
- 17.5 TIRES (p.88)

// 1. LOCATION OF IMPORTANT LABELS

Read and understand all of the labels on your vehicle. They contain important information for safe and proper operation of your vehicle. Never remove any labels from your vehicle. If a label becomes difficult to read or comes off, a replacement label is available from your Apollo dealer.

1.1 Canada

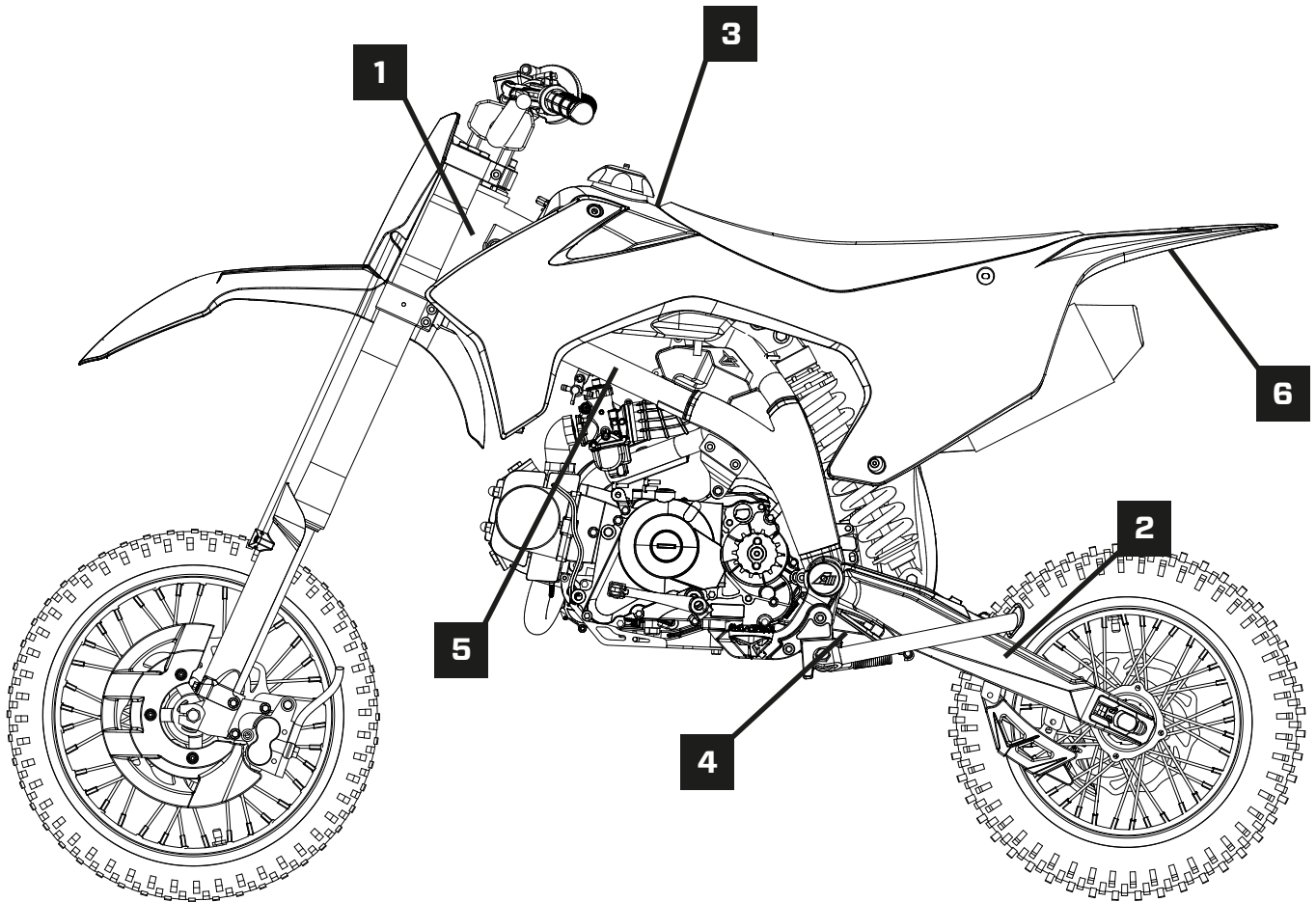

1

Reference Standard: EN16029		CE
Product: off-road dirt bike		
Rated Power: *** kW	Displacement: ***CC	
Model: *****	Vehicle Mass: ***kg	
Engine *****	Date **/**/**	
VIN *****		
Zhejiang Apollo Motorcycle Manufacturer CO. Ltd Jinyan hill Industrial Are. Quanxi Town, Wuyi City, Zhejiang Province, China		

2

IMPORTANT : LA TENSION DE CHAÎNE

Il doit y avoir un jeu d'un ou deux doigts au niveau de la chaîne (soit 15 – 25mm). Sinon celle-ci peut être ajusté à partir du tendeur de chaîne arrière.

IMPORTANT: CHAIN TENSION

The chain should have a play of one or two fingers (15-25mm). If not it can be adjusted from the Rear chain tensioners.

3

⚠ ATTENTION !

Carburant : Sans plomb 98

Veillez mettre le moteur à l'arrêt lors de l'alimentation en carburant afin d'éviter toute inflammation ou explosion

⚠ WARNING

GASOLING93 RON MIN

please turn off the bike engine when fueling to avoid any fire or explosion

4

Ceci est un tuyau de mise à l'air. Il faut couper le lien en plastique avant de démarrer le moteur. Ce tuyau ne doit jamais être bouché.

This is an engine vent tube. Please cut the plastic cable when the first ride and keep the vent tube clear off.

5

⚠ WARNING

This vehicle is a competition vehicle and is for use exclusively in closed-course competition.

Ceci est un véhicule de compétition destiné à être utilisé exclusivement dans les courses en circuit fermé.

6

⚠ WARNING ⚠ ATTENTION

100 kPa 100 kPa
1.00 kgf/cm² 1.00 kgf/cm²
15 psi 15 psi

Details p.14

1.2 Europe

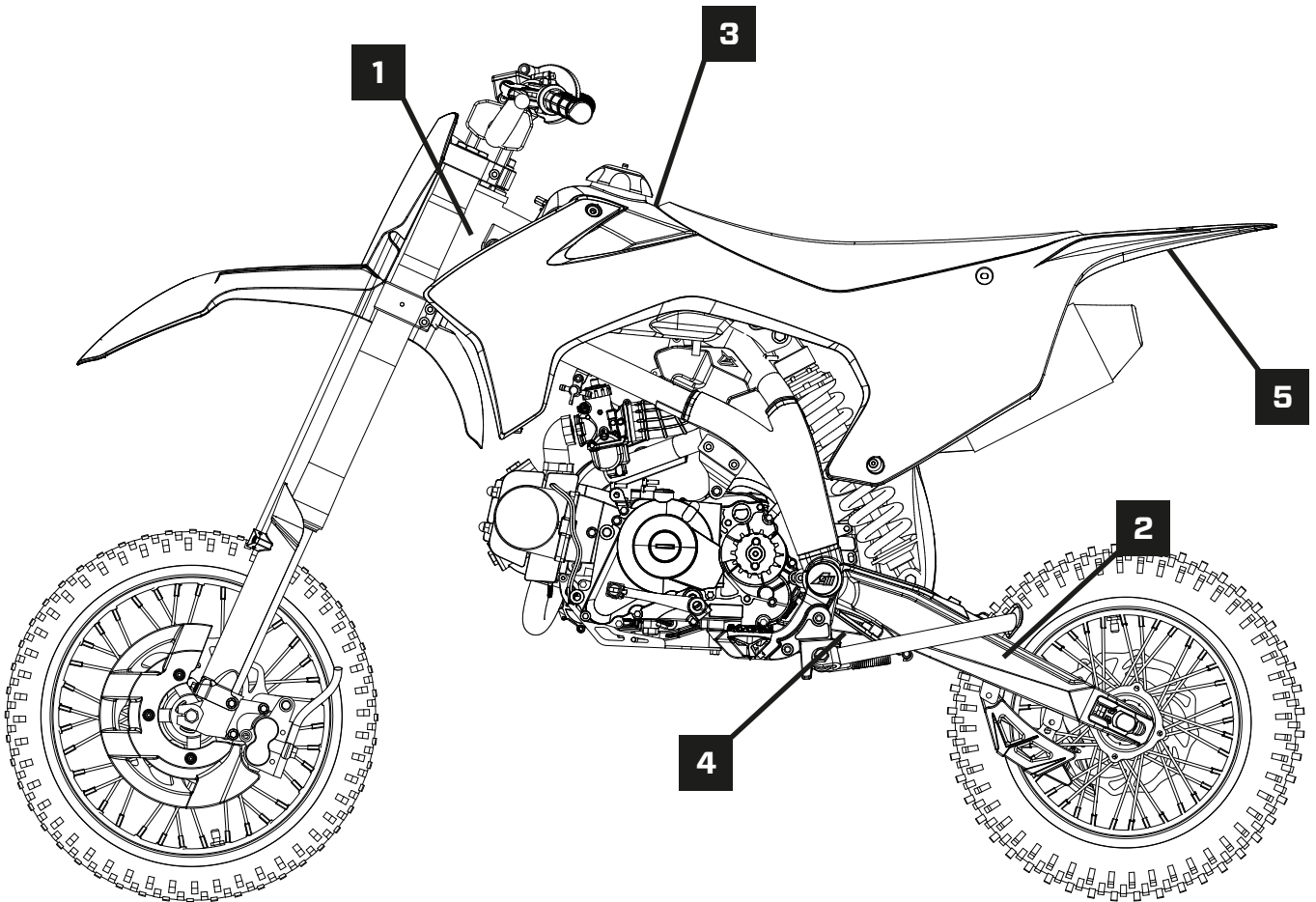

1

Reference Standard: EN16029
 Product: off-road dirt bike

Rated Power: *** kW Displacement: ***CC
 Model: **** Vehicle Mass: ***kg

Engine: ***** Date: **/**/**

VIN: *****

Zhejiang Apollo Motorcycle Manufacturer CO. Ltd
 Jinyan hill Industrial Are. Quanxi Town, Wuyi City, Zhejiang Province, China

3

⚠ WARNING

GASOLING93 RON MIN

please turn off the bike engine when fueling to avoid any fire or explosion

2







IMPORTANT: CHAIN TENSION

The chain should have a play of one or two fingers (15-25mm).
 If not it can be adjusted from the Rear chain tensioners.

4

This is an engine vent tube. Please cut the plastic cable when the first ride and keep the vent tube clear off.

Familiarize yourself with the following pictograms and read the explanatory text.

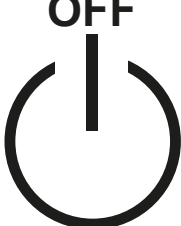
	<p>Read the Owner's manual.</p>
	<p>Always use an approved helmet and protective gear.</p>
	<p>Use from 6 years old. Operation of this motorcycle by children under the age of 6 increase the risk of severe injury or death.</p>
	<p>Adult supervision required for children.</p>
	<p>Never use on paved roads.</p>
	<p>Never carry passengers.</p>
	<p>Turn off the main switch after riding to avoid draining the battery.</p>

	<p>Use unleaded gasoline only.</p>
	<p>Measure the tire pressure when the tires are cold.</p>
	<p>No horn: avoid driving in a space that can be accessed by other people</p>
	<p>Excessive noise: avoid driving in a space can be accessed by other people. Your dirtbike exceeds the noise level eligible. it is strongly recommended to wear hearing protection.</p>
	<p>Projection due to wheel rotation: avoid ride in a space that can be accessed by other people</p>
	<p>You must take into account the level of vibration excess of your vehicle at the level of the members higher and your entire body. As a safety measure it is important to always check the tightness of the bike before and after use.</p>
	<p>Avoid contact with the hot parts of the vehicle: exhaust pipe, exhaust pipe.</p>
 <p>100 kPa 100 kPa 1.00 kgf/cm² 1.00 kgf/cm² 2,5 psi 2,5 psi</p>	<p>Adjust the tire pressure. Improper tire pressure can cause loss of control. Loss of control can result in severe injury or death.</p>

Reference Standard: EN16029
Product: off-road dirt bike



Rated Power: *** kW

Displacement: ***CC

Model: *****

Vehicle Mass: ***kg

Engine *****

Date **/**/**

VIN *****

Zhejiang Apollo Motorcycle Manufacturer CO, Ltd
Jinyan hill Industrial Are. Quanxi Town, Wuyi City, ZHEJIANG Province. China

(Engine:) Engine vin number
(Date:) Date of production
(VIN:) Frame vin number

1.3 Oceania and South Africa

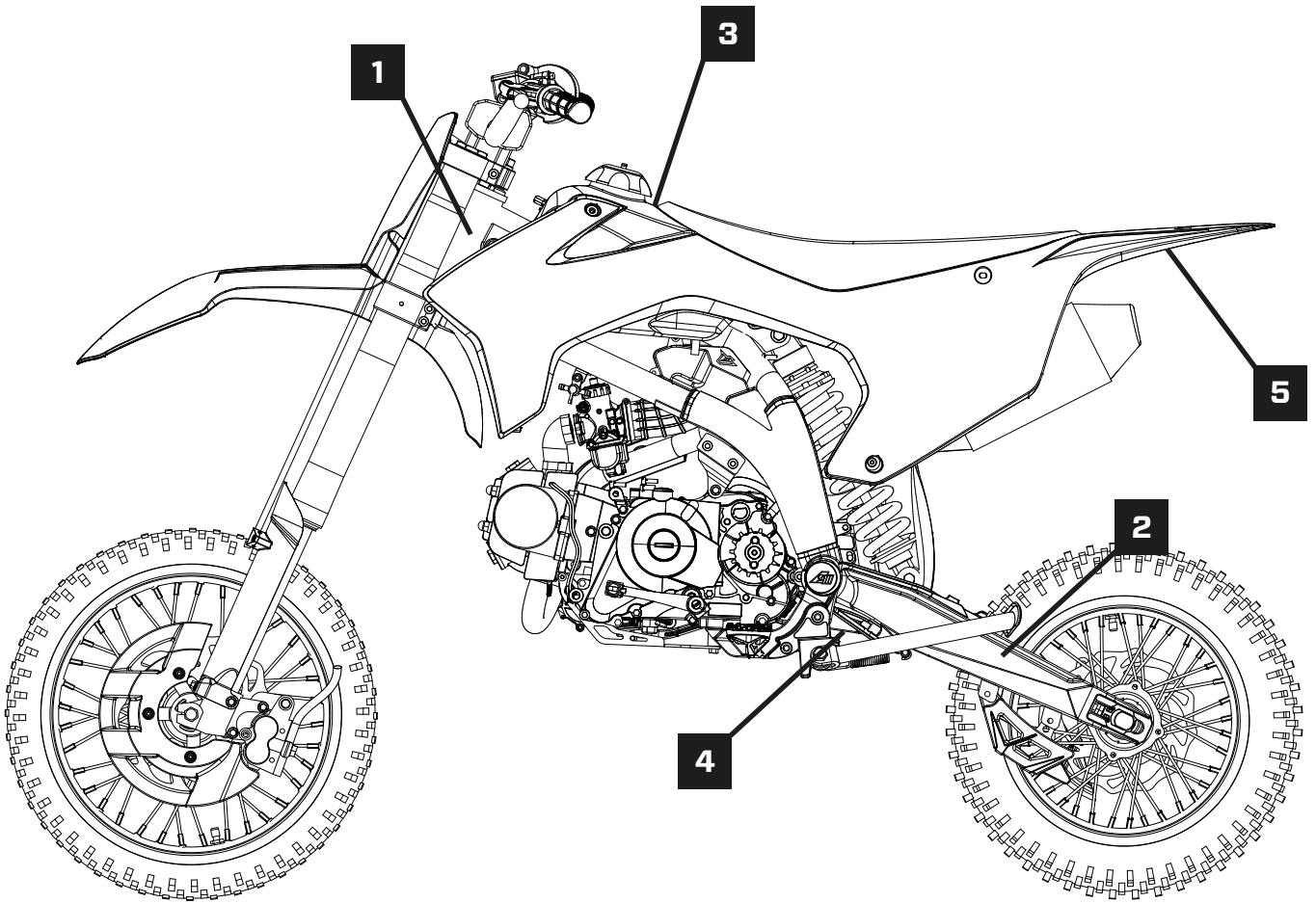

1

Reference Standard: EN16029		CE
Product: off-road dirt bike		
Rated Power: *** kW	Displacement: ***CC	
Model: ****	Vehicle Mass: ***kg	
Engine: *****	Date: **/**/**	
VIN: *****		
<small>Zhejiang Apollo Motorcycle Manufacturer CO. Ltd Jinyan Hill Industrial Are. Quaxi Town, Wuyi City, Zhejiang Province, China</small>		

3

⚠ WARNING

GASOLING93 RON MIN

please turn off the bike engine when fueling to avoid any fire or explosion

2

IMPORTANT: CHAIN TENSION

The chain should have a play of one or two fingers (15-25mm). If not it can be adjusted from the Rear chain tensioners.

4

This is an engine vent tube. Please cut the plastic cable when the first ride and keep the vent tube clear off.

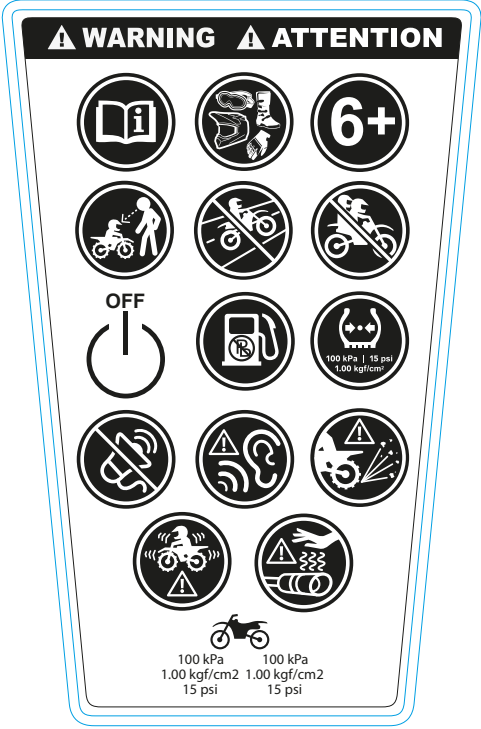

Details p.14

// 2. SAFETY ADVICE

2.1 se definition - intended use

Apollo are designed and built to withstand the normal stresses and strains of competitive use. The motorcycles comply with currently valid regulations and categories of the top international motorsport organizations.



The motorcycle may only be used in closed off areas remote from public road traffic.

2.2 Safety advice

A number of safety instructions need to be followed to operate the vehicle safely. Therefore, read this manual carefully. The safety instructions are highlighted in the text and are referred to at the relevant passages.







The vehicle has various information and warning labels at prominent locations. Do not remove information/warning labels. If they are missing, you or others may not recognize dangers and may therefore be injured.

2.3 Be a Responsible Owner

As the vehicle's owner, you are responsible for the safe and proper operation of your motorcycle. Motorcycles are single-track vehicles. Their safe use and operation are dependent upon the use of proper riding techniques as well as the expertise of the operator. Every operator should know the following requirements before riding this motorcycle.

He or she should:

-  Obtain thorough instructions from a competent source on all aspects of motorcycle operation.
-  Observe the warnings and maintenance requirements in this Owner's Manual.
-  Obtain qualified training in safe and proper riding techniques.
-  Obtain professional technical service as indicated in this Owner's Manual and/or when made necessary by mechanical conditions.
-  Never operate a motorcycle without proper training or instruction. Take a training Displacement. Beginners should receive training from a certified instructor. Contact an authorized motorcycle dealer to find out about the training Displacements nearest you.

2.4 Safe Riding





Perform the pre-operation checks each time you use the vehicle to make sure it is in safe operating condition. Failure to inspect or maintain the vehicle properly increases the possibility of an accident or equipment damage. See page  .36 for a list of pre-operation checks.

This motorcycle is designed for off-road use only, therefore, it is illegal to operate it on public streets, roads, or highways, even a dirt or gravel one. Off-road use on public lands may be illegal. Please check local regulations before riding.



This motorcycle is designed to carry the operator only. No passengers.

The failure of motorists to detect and recognize motorcycles in traffic is the predominating cause of automobile/motorcycle accidents. Many accidents have been caused by an automobile driver who did not see the motorcycle. Making yourself conspicuous appears to be very effective in reducing the chance of this type of accident.

Therefore:

-  Wear a brightly colored jacket.
-  Use extra caution when you are approaching and passing through intersections, since intersections are the most likely places for motorcycle accidents to occur.
-  Ride where other motorists can see you. Avoid riding in another motorist's blind spot.
-  Never maintain a motorcycle without proper knowledge. Contact an authorized motorcycle dealer to inform you on basic motorcycle maintenance. Certain maintenance can only be carried out by certified staff.

Many accidents involve inexperienced operators.

-  Know your skills and limits. Staying within your limits may help you to avoid an accident.
-  We recommend that you practice riding your motorcycle until you have become thoroughly familiar with the motorcycle and all of its controls.

Many accidents have been caused by error of the motorcycle operator. A typical error made by the operator is veering wide on a turn due to excessive speed or undercornering (insufficient lean angle for the speed). Never travel faster than warranted by conditions.

Ride cautiously in unfamiliar areas. You may encounter hidden obstacles that could cause an accident.

The posture of the operator is important for proper control. The operator should keep both hands on the handlebar and both feet on the operator footrests during operation to maintain control of the motorcycle.

Never ride under the influence of alcohol or other drugs.

2.5 Protective Apparel

The majority of fatalities from motorcycle accidents are the result of head in-juries. The use of a safety helmet is the single most critical factor in the prevention or reduction of head injuries.

- 👤 Always wear an approved helmet.
- 👤 Wear a face shield or goggles. Wind in your unprotected eyes could contribute to an impairment of vision that could delay seeing a hazard.
- 👤 The use of a jacket, heavy boots, trousers, gloves, etc., is effective in preventing or reducing abrasions or lacerations.
- 👤 Never wear loose-fitting clothes, otherwise they could catch on the control levers, footrests, or wheels and cause injury or an accident.
- 👤 Always wear protective clothing that covers your legs, ankles, and feet. The engine or exhaust system become very hot during or after operation and can cause burns.

2.6 Avoid Carbon Monoxide Poisoning

All engine exhaust contains carbon monoxide, a deadly gas. Breathing carbon monoxide can cause head-aches, dizziness, drowsiness, nausea, confusion, and eventually death. Carbon Monoxide is a colorless, odor-less, tasteless gas which may be present even if you do not see or smell any engine exhaust. Deadly levels of carbon monoxide can collect rapidly and you can quickly be overcome and unable to save yourself. Also, deadly levels of carbon monoxide can linger for hours or days in enclosed or poorly ventilated areas.

If you experience any symptoms of carbon monoxide poisoning, leave the area immediately, get fresh air, and SEEK MEDICAL TREATMENT.

- 👤 Do not run engine indoors. Even if you try to ventilate engine exhaust with fans or open windows and doors, carbon monoxide can rapidly reach dangerous levels.
- 👤 Do not run engine in poorly ventilated or partially enclosed areas such as barns, garages, or car-ports.
- 👤 Do not run engine outdoors where engine exhaust can be drawn into a building through openings such as windows and doors.

2.7 Loading

Adding accessories to your motorcycle can adversely affect stability and handling if the weight distribution of the motorcycle is changed. To avoid the possibility of an accident, use extreme caution when adding accessories to your motorcycle. Use extra care when riding a motorcycle that has added accessories. Here are some general guidelines to follow if adding accessories to your motorcycle:

Operation of an overloaded vehicle could cause an accident.

- 👉 The weight of the operator must not exceed 100 kg (220 lb).
- 👉 Accessory weight should be kept as low and close to the motorcycle as possible. Securely pack your heaviest items as close to the center of the vehicle as possible and make sure to distribute the weight as evenly as possible on both sides of the motorcycle to minimize imbalance or instability.

Shifting weights can create a sudden imbalance. Make sure that accessories are securely attached to the motorcycle before riding. Check accessory mounts frequently.

- 👉 Properly adjust the suspension for your load (suspension-adjustable models only), and check the condition and pressure of your tires.
- 👉 Never attach any large or heavy items to the handlebar, front fork, or front fender.

2.8 Genuine Apollo Accessories

Choosing accessories for your vehicle is an important decision. Genuine Apollo accessories, which are available only from a Apollo dealer, have been designed, tested, and approved by Apollo for use on your vehicle. Many companies with no connection to Apollo manufacture parts and accessories or offer other modifications for Apollo vehicles. Apollo is not in a position to test the products that these aftermarket companies produce. Therefore, Apollo can neither endorse nor recommend the use of accessories not sold by Apollo or modifications not specifically recommended by Apollo, even if sold and installed by a Apollo dealer.

2.9 Aftermarket Parts, Accessories, and Modifications

While you may find aftermarket products similar in design and quality to genuine Apollo accessories, recognize that some aftermarket accessories or modifications are not suitable because of potential safety hazards to you or others. Installing aftermarket products or having other modifications performed to your vehicle that change any of the vehicle's design or operation characteristics can put you and others at greater risk of serious injury or death. You are responsible for injuries related to changes in the vehicle. Keep the following guidelines in mind, as well as those provided under "Loading" when mounting accessories.

Observe the following instructions when fitting accessories, as well as those given in section **"2.7 Charge"**. 📖.22

Never install accessories that would impair the performance of your motorcycle. Carefully inspect the accessory before using it to make sure that it does not in any way reduce ground clearance or cornering clearance, limit suspension travel, steering travel or control operation.

- ⓘ Accessories fitted to the handlebar or the front fork area can create instability due to improper weight distribution. If accessories are added to the handlebar or front fork area, they must be as lightweight as possible and should be kept to a minimum.
- ⓘ Bulky or large accessories may seriously affect the stability of the motorcycle. Wind may attempt to lift the motorcycle, or the motorcycle may become unstable in cross winds.
- ⓘ Certain accessories can dis-place the operator from his or her normal riding position. This improper position limits the freedom of movement of the op

Use caution when adding electrical accessories. If electrical accessories exceed the capacity of the motorcycle's electrical sys-tem, an electric failure could result, which could cause a dangerous loss of lights or engine power.

2.10 Aftermarket Tires and Rims

The tires and rims that came with your motorcycle were designed to match the performance capabilities and to provide the best combination of handling, braking, and comfort. Other tires, rims, sizes, and combinations may not be appropriate. Refer to page **1189** for tire specifications and more in-formation on replacing your tires.

2.11 Transporting the Motorcycle

Be sure to observe following instructions before transporting the motorcycle in another vehicle.

- ⓘ Remove all loose items from the motorcycle.
- ⓘ Check that the fuel cock is in the close position (down) and that there are no fuel leaks. Point the front wheel straight ahead on the trailer or in the truck bed, and choke it in a rail to pre-vent movement.
- ⓘ Shift the transmission in gear (for models with a manual transmission).
- ⓘ Secure the motorcycle with tie-downs or suitable straps that are attached to solid parts of the motorcycle, such as the frame or up-per front fork triple clamp (and not, for example, to rubber-mounted handlebars or turn signals, or parts that could break). Choose the location for the straps carefully so the straps will not rub against painted surfaces during transport.
- ⓘ The suspension should be compressed somewhat by the tie-downs, if possible, so that the motorcycle will not bounce excessively during transport.

2.12 Work rules

Special tools are necessary for certain tasks. The tools are not contained in the vehicle but can be ordered under the number in parentheses. E.g.: bearing puller...

During assembly, non-reusable parts (e.g. self-locking screws and nuts, seals and seal rings, O-rings, pins, lock washers) must be replaced by new parts.

In some instances, a thread locker (e.g. Loctite®) is required. The manufacturer instructions for use must be followed.

After disassembly, clean the parts that are to be reused and check them for damage and wear. Change damaged or worn parts.

After you complete the repair or service work, check the operating safety of the vehicle.

2.13 Environment

If you use your motorcycle responsibly, you can ensure that problems and conflicts do not occur. To protect the future of the motorcycle sport, make sure that you use your motorcycle legally, display environmental consciousness, and respect the rights of others. When disposing of used oil, other operating and auxiliary fluids, and used components, comply with the laws and regulations of the respective country.

Because motorcycles are not subject to the EU regulations governing the disposal of used vehicles, there are no legal regulations that pertain to the disposal of an end-of-life motorcycle. Your authorized Apollo dealer will be glad to advise you.

// 3. VIEW OF VEHICLE

3.1 View of vehicle, front left (example)



1	Clutch lever (p. 27)
2	Filler cap (p. 29)
3	Filler cap (p. 71)
4	Engine number
5	Shift lever (p. 31)
6	Fuel tap (p. 30)
7	Side stand (p. 31)
8	Shock absorber (V-TRAAK option) (p. 45)
9	Choke (p. 30)
10	Idle speed adjusting (p. 76)
11	Kill switch (p. 27)

Engine Number :

3.2 View of vehicle, front right (example)



1	Clutch lever (p. 27)
2	Kill switch (p. 27)
3	Hand brake lever (p. 27)
4	Electric starter button (p. 28)
5	Foot brake lever (p. 31)
6	Checking the brake fluid level (p. 49)
7	Removing the air filter (p. 68)

Chassis number:

// 4. CONTROLS

4.1 Clutch lever

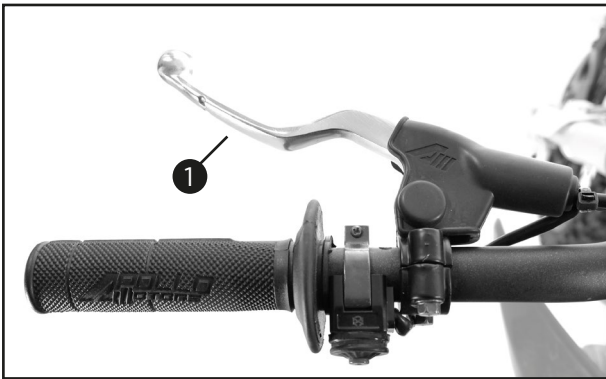

The clutch lever 1 is fitted on the left side of the handlebar.

4.2 Hand brake lever



Hand brake lever 1 is fitted on the right side of the handlebar. The front brake is engaged using the hand brake lever.

4.3 Throttle grip



The throttle grip 1 is fitted on the right side of the handlebar.

4.4 Kill switch



Kill switch 1 is fitted on the left side of the handlebar.

Possible states:

// Kill switch in basic position

In this position, the ignition circuit is closed and the engine can be started.

// Kill switch pressed

In this position, the ignition circuit is interrupted, a running engine stops, and a non-running engine will not start.

4.5 Electric starter button (only for electric star)

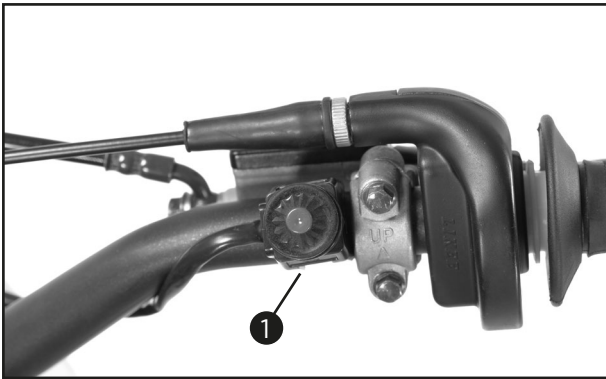

Electric starter button 1 is fitted on the right side of the handlebar.

Possible states:

// Electric starter button in basic position

// Electric starter button pressed

In this position, the electric starter is actuated.

4.6 Service hour counter

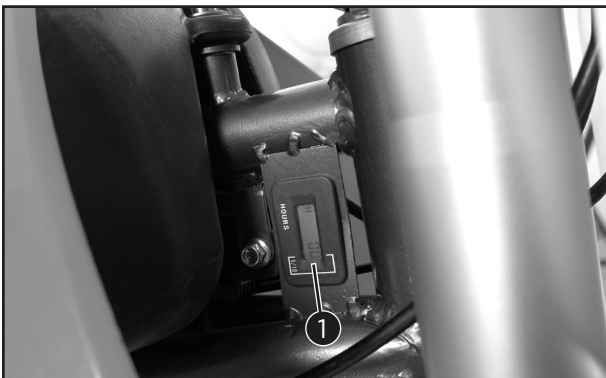

Service hour counter 1 is fitted in front of the handlebar.

It shows the total number of service hours of the engine.

The service hour counter begins counting when the engine is started and stops when the engine is switched off.



The value indicated by the service hour counter cannot be cleared or adjusted.

4.7 ON/OFF switch



This button 1 does a general cut of the motorcycle.







Check this button is the ON position before starting the bike.

4.8 Opening filler cap



Fire hazard. Fuel is highly flammable.

-  Do not refuel the vehicle in the vicinity of open flames or lit cigarettes. Switch off the engine for refueling.
-  Make sure that no fuel is spilled; particularly not on hot parts of the vehicle.
-  If any fuel is spilled, wipe it off immediately.
-  Observe the specifications for refueling.



- Danger of poisoning Fuel is poisonous and a health hazard.
- Avoid skin, eye and clothing contact with fuel.
- Immediately consult a doctor if you swallow fuel.
- Do not inhale fuel vapors.
- In case of skin contact, rinse the affected area with plenty of water.
- Rinse the eyes thoroughly with water, and consult a doctor in case of fuel contact with the eyes.
- Change your clothing in case of fuel spills on them.
- Keep fuels correctly in a suitable canister, and out of the reach of children.



The fuel in the fuel tank expands when warm and can escape if overfilled.

Improper handling of fuel is a danger to the environment. Do not allow fuel to enter the groundwater, the soil, or the sewage system.

Turn the tank cap 1 counterclockwise and pull it up.

4.9 Closing filler cap

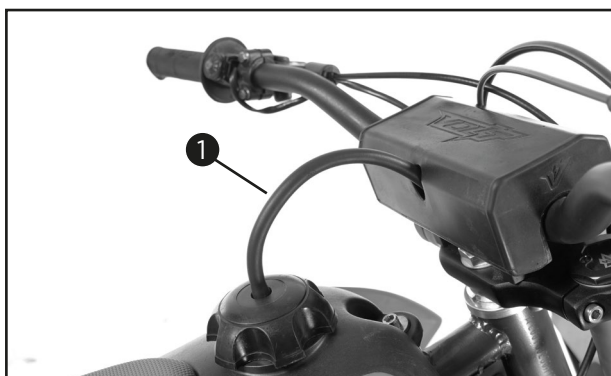

Closing filler cap

Put the tank cap on and turn it clockwise.



Run the fuel tank breather hose 1 without kinks.

4.10 Fuel tap

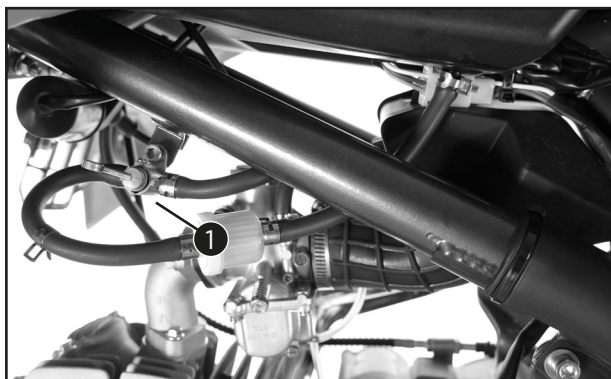

Fuel tap 1 is on the left of the fuel tank.

Possible states

The fuel cock supplies fuel from the tank to the carburetor while filtering it also.

The fuel cock has two positions:

// Close : Arrow mark pointing to the down

With the lever in this position, fuel will not flow. Always return the lever to this position when the engine is not running.

// Open : Arrow mark pointing to the left

With the lever in this position, fuel flows to the carburetor. Normal riding is done with the lever in this position.

4.11 Choke

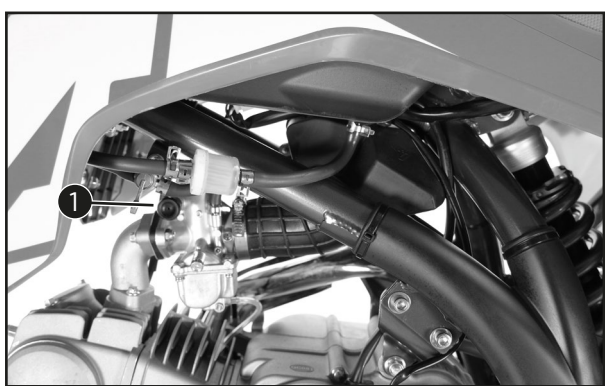

Choke 1 is fitted on the left side of the carburetor.

Activating the choke function frees a drill hole in the carburetor through which the engine can draw extra fuel. This results in a richer fuel-air mixture, which is needed for a cold start.



If the engine is warm, the choke function must be deactivated.

Possible states:

// Choke function activated

Choke knob is in drawn position. The O-ring is visible

// Choke function deactivated

Choke knob is in depressed position. The O-ring is not visible

4.12 Kick starter

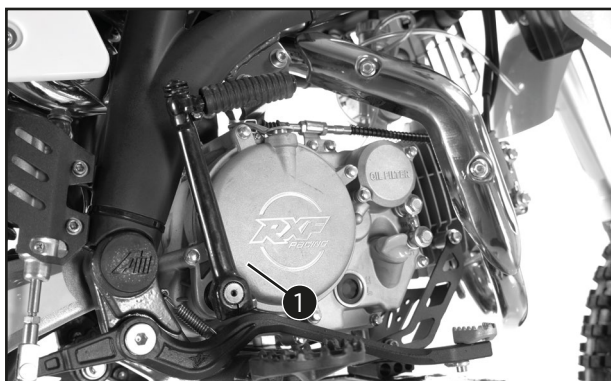

Kick starter 1 is fitted on the right side of the engine. The kick starter can be swiveled.



Before riding, swing the kick starter inwards towards the engine.

4.13 Foot brake lever



Foot brake lever 1 is located in front of the right footrest. The rear brake is engaged with the foot brake lever.

4.14 Shift lever

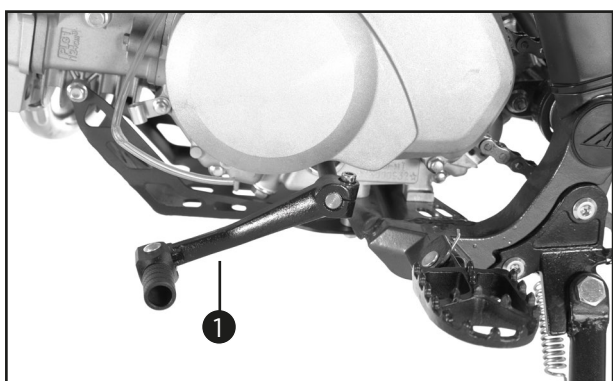

Shift lever 1 is mounted on the left of the engine.

The neutral or idle position is before the first gear. (N-1-2-3-4)

The neutral or idle position is between the first and second gears for the Zongshen 190cc only. (1-N-2-3-4-5)

4.15 Side stand

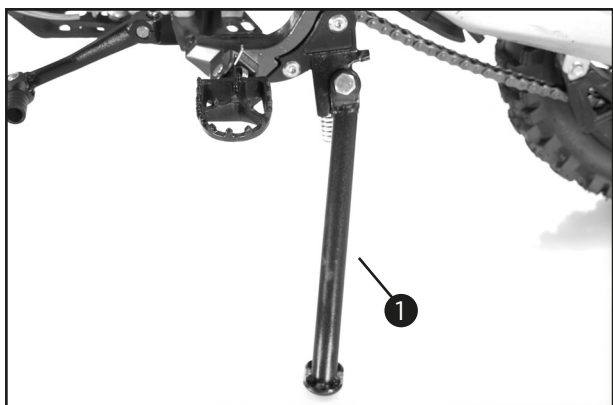

The side stand 1 is on the left side of the vehicle.

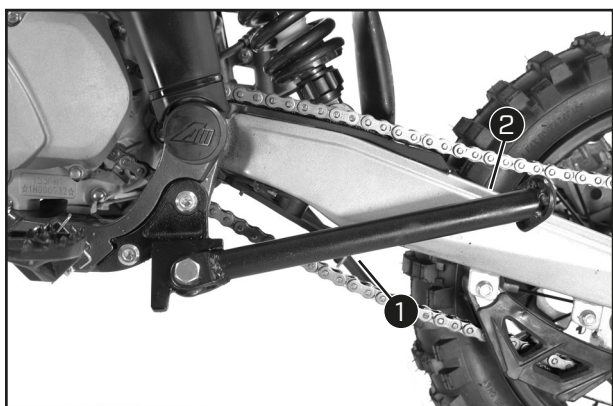

The side stand 1 is on the left side of the vehicle.



When you are riding, side stand 1 must be folded up 2

// 5. PREPARING FOR USE

5.1 First use



Danger of accidents

A lack of physical and mental readiness on the part of the child poses a major risk. Children often underestimate or fail to recognize dangerous situations.

- *Your child must already be able to ride a bicycle.*
- *Your child must be able to put the vehicle upright independently after a fall.*
- *Your child must understand that regulations and instructions from you or from other guardians must be followed.*
- *Make it clear to your child that he or she should not, under any circumstances, operate the vehicle without supervision.*
- *Make it clear to your child that he or she may only drive at speeds commensurate with the child's riding abilities and the road conditions.*
- *Do not ask too much of your child.*
- *Do not consider participation in competitive activities until your child's stamina, riding techniques and motivation are at the necessary levels.*
- *Only let your child ride on the vehicle if he or she is physically and mentally ready.*



Risk of injury

Missing or poor protective clothing presents an increased safety risk.

- *Ensure your child wears appropriate protective clothing such as helmet, boots, gloves as well as trousers and a jacket with protectors on all rides.*
- *Always use protective clothing for your child that is in good condition and meets the legal requirements.*
- *When you ride a motorcycle, set an example for your child and wear suitable protective clothing.*



Danger of crashing

Different tire tread patterns on the front and rear wheel impair the handling characteristic. Different tire tread patterns can make the vehicle significantly more difficult to control.

- *Make sure that only tires with a similar tire tread pattern are fitted to the front and rear wheel.*



Danger of accidents

An unadapted riding style constitutes a major risk.

- *Ensure that your child adapts the riding speed to the road conditions and to his or her riding abilities.*



Danger of accidents

The vehicle is not designed to carry passengers.

- *Do not ride with a passenger.*

**Danger of accidents**

The brake system fails in the event of overheating.

If the foot brake lever is not released, the brake linings drag continuously.

- *Ensure that your child raises his or her foot from the foot brake lever if he or she does not want to brake.*

**Danger of accidents**

The suspension components will become damaged or destroyed if overloaded.

- *Do not exceed the maximum permissible weight of the rider.*

**Risk of misappropriation**

People who act without authorization endanger themselves and others.

- *Do not leave the vehicle unattended if the engine is running.*
- *Protect the vehicle against access by unauthorized persons.*







When using your motorcycle, remember that others may feel disturbed by excessive noise.

Carefully read the entire Owner's Manual together with your child before going for the first ride.



Pay special attention to the safety warnings and injury risks.

Explain to your child the techniques of riding and falling, e.g. how shifting weight can influence handling characteristics.

- Familiarize your child with the controls.
- Adjust the basic position of the clutch lever. ( . 27)
- Adjust the basic position of the hand brake lever. ( . 27)
- Adjust the basic position of the foot brake lever. ( . 53)
- Adjust the basic position of the shift lever. ( . 77)
- Before using the vehicle for the first time, ensure that the basic settings of the chassis are suitable for the weight of your child.
- Accustom your child to the handling of the motorcycle on suitable terrain, preferably on a large open meadow.



To give your child a feeling for the brake system, you should push your child at first. Do not start the engine until your child is able to apply the necessary front brake pressure.

Your motorcycle is not approved for use on public roads.

When off road, it is recommended that you are accompanied by another person on another vehicle so that you can help each other.

Initially, let your child ride to another person who can help your child stop and turn.

- Erect obstacles for your child to navigate around to accustom your child to handling the vehicle.
- Your child should also try to ride as slowly as possible and in a standing position to get a better feeling for the vehicle.
- Do not let your child ride on terrain that exceeds your child's capabilities and experience. Your child should hold the handlebar firmly with both hands and keep his or her feet on the footrests when riding.
- Do not exceed the maximum permissible weight of the rider.

Guideline

Check the spoke tension. (📖.57)



The spoke tension must be checked after half an hour of operation.

Difficult riding conditions are:

- Rides on dry sand.
- Rides on wet sand.
- Rides on wet and muddy surfaces.
- Rides at high temperature and slow speed.
- Riding at low temperature and in snow.

5.2 Running in the engine

There is never a more important period in the life of your engine than the first 5 hours of riding. It is also important to accustom the rider to the motorcycle during this time. Please read the following information carefully.

Since the engine is brand new, do not put an excessive load on it for the first 5 hours of operation. The various parts in the engine wear and polish them-selves to the correct operating clearances. During this period, prolonged full-throttle operation or any condition that might result in engine overheating must be avoided. However, momentary full-throttle operation under load (i.e., two to three seconds maximum) does not harm the engine. Each full-throttle acceleration should be followed with a substantial rest period for the engine. To allow the engine to cool down from the temporary buildup of heat, cruise at a lower engine speed. After the first 5 hours of operation, thoroughly check the motorcycle for loose parts, oil leakage and any other problems. Be sure to inspect and make adjustments thoroughly, especially cables. In addition, check all fittings and fasteners for looseness, and tighten if necessary.

Guideline

Maximum engine performance:

- During the first 3 operating hours < 70 %
- During the first 5 operating hours < 100 %

Avoid fully opening the throttle!



If any engine trouble should occur during the engine break-in period, immediately have a Apollo dealer check the vehicle.

During the running-in phase, do not exceed the specified engine performance.

// 6. RIDING INSTRUCTIONS

6.1 Checks and maintenance work when preparing for use

Inspect your vehicle each time you use it to make sure the vehicle is in safe operating condition. Always follow the inspection and maintenance procedures and schedules described in the Owner's Manual.



Failure to inspect or maintain the vehicle properly increases the possibility of an accident or equipment damage. Do not operate the vehicle if you find any problem. If a problem cannot be corrected by the procedures provided in this manual, have the vehicle inspected by a APOLLO dealer.

Before using this vehicle, check the following points:

Fuel	<ul style="list-style-type: none">• Check fuel level in fuel tank. (.29)• Refuel if necessary.• Check fuel line for leakage.• Check fuel tank breather hose for obstructions, cracks or damage, and check hose connection.
Engine oil	<ul style="list-style-type: none">• Check oil level in oil tank. (.78)• If necessary, add recommended oil to specified level.• Check vehicle for oil leakage.
Brakes	<ul style="list-style-type: none">• Check the brake fluid level of the front brake. (.49)• Check the rear brake fluid level. (.49)• Check the front brake linings. (.52)• Check the rear brake linings. (.52)• Check that the brake system is functioning properly.
Chain	<ul style="list-style-type: none">• Check for chain dirt accumulation. (.69)• Check the chain, rear sprocket, engine sprocket, and chain guide. (.71)• Check the chain tension. (.70)
Wheels	<ul style="list-style-type: none">• Check the tire condition. (.56)• Check the tire air pressure. (.57)• Check the spoke tension. (.57)
Air filter	<ul style="list-style-type: none">• Check the air filter. (.68)
Controls	<ul style="list-style-type: none">• Check the settings of all controls and ensure that they can be operated smoothly.
Screws	<ul style="list-style-type: none">• Check all screws, nuts and hose clamps regularly for tightness.

6.2 Starting

Always carry out these checks before each departure to ensure that the vehicle can be driven safely.

Always follow the inspection and maintenance procedures and intervals in this owner's manual.

Danger of poisoning

Exhaust gases are toxic and inhaling them may result in unconsciousness and death.

- Always make sure there is sufficient ventilation when running the engine.
- Use an effective exhaust extraction system when starting or running the engine in an enclosed space.

Remarque :

Engine damage

High revving speed with a cold engine negatively impacts the lifespan of the engine.

- Always run the engine warm at a low speed.



If the motorcycle is unwilling to start, the cause can be old fuel in the float chamber. The flammable elements of the fuel evaporate after a long time of standing.

If the float chamber is filled with fresh fuel, the engine starts immediately.

The motorcycle has been out of use for more than 1 week

The motorcycle has been out of use for more than 1 week:

- Empty the carburetor float chamber.
- Turn the knurled screw on the fuel tap all the way counterclockwise.

Fuel can flow from the fuel tank to the carburetor:

- Remove the stand
- Pull the choke all the way to the stop
- Forcefully step on the kick starter, pushing it all the way forward

6.3 Electric starting (electric start only)

- Press the electric starter button



Press the electric starter button for a maximum of 5 seconds. Wait for 30 seconds before a further attempt at starting.

At temperatures below 15 °C (60 °F), several attempts at starting may be necessary to warm-up the lithium-ion battery and thereby increase the starting power.

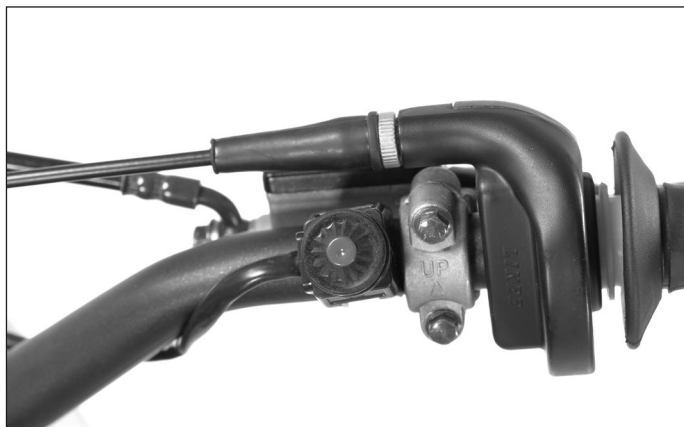

6.4 Riding

Pull the clutch lever, engage 1st gear, release the clutch lever slowly and simultaneously open the throttle carefully.



Danger of accidents

If you change down at high engine speed, the rear wheel blocks and the engine races.
Do not change into a low gear at high engine speed.



If you hear unusual noises while riding, stop immediately, switch off the engine and contact an authorized Apollo workshop.

First gear is used for starting off and for steep inclines.

- Shift into a higher gear when conditions allow (incline, road situation, etc.). To do so, release the throttle while simultaneously pulling the clutch lever, shift into the next gear, release the clutch lever and open the throttle.
- If you pushed the cold start button while starting, open the throttle briefly and release the throttle grip or turn the throttle grip for-ward.
- After reaching maximum speed by fully opening the throttle grip, turn the throttle back so it is 3/4 open. This will barely reduce the speed but fuel consumption will be considerably lower.
- Always open the throttle only as much as the engine can handle – abrupt throttle opening increases fuel consumption.
- To shift down, apply the brakes and close the throttle at the same time.
- Pull the clutch lever and shift into a lower gear, release the clutch lever slowly, and either open the throttle or shift again.
- Switch off the engine if running at idle or standing for a long time. Guideline ≥ 1 min
- Avoid frequent and longer slipping of the clutch. As a result the engine oil, engine and cooling system heat up.
- Ride at a low engine speed instead of at a high engine speed with a slipping clutch.

6.5 Braking



Danger of accidents

Excessively forceful application of the brakes blocks the wheels.

- Explain to your child that he or she must adapt the braking to the traffic situation and the road conditions.



Danger of accidents

A spongy pressure point on the front or rear brake reduces braking efficiency.

Check the brake system and do not allow your child to continue riding until the problem is eliminated.



Danger of accidents

Moisture and dirt impair the brake system.

- Explain to your child that he or she must brake carefully several times to dry out and remove dirt from the brake linings and the brake discs.
- On sandy, wet, or slippery surfaces, use the rear brake.
- Always finish braking before you go into a bend.

6.6 Stopping



Risk of misappropriation

People who act without authorization endanger themselves and others.

- Do not leave the vehicle unattended if the engine is running.
- Protect the vehicle against access by unauthorized persons.



Danger of burns

Some vehicle components become very hot when the vehicle is operated.

- Do not touch any parts such as the exhaust system, radiator, engine, shock absorber, or brake system before the vehicle parts have cooled down.
- Let the vehicle parts cool down before you perform any work on the vehicle.

NOTE : Danger of damage

The parked vehicle can roll away or fall over.

- Park the vehicle on a firm and level surface.

NOTE : Fire hazard

Hot vehicle components pose a fire hazard and explosion risk.

- Do not park the vehicle near to materials which are highly flammable or explosive.
- Allow the vehicle to cool down before covering it.
- Brake the motorcycle.
- Shift the transmission to idle.
- Press and hold the kill switch while the engine is idling until the engine stops.
- Park the motorcycle on firm ground.

6.7 Transport

Note : Danger of damage

The parked vehicle can roll away or fall over.

- Park the vehicle on a firm and level surface.

NOTE : Fire hazard

Hot vehicle components pose a fire hazard and explosion risk.



- Do not park the vehicle near to materials which are highly flammable or explosive.
- Allow the vehicle to cool down before covering it.
- Switch off the engine.
- Use tension belts or other suitable devices to secure the motorcycle against accidents or falling over.

6.8 Refueling

Fire hazard

Fuel is highly flammable.

The fuel in the fuel tank expands when warm and can escape if overfilled.

-  Do not refuel the vehicle in the vicinity of open flames or lit cigarettes. Switch off the engine for refueling.
-  Make sure that no fuel is spilled; particularly not on hot parts of the vehicle. If any fuel is spilled, wipe it off immediately.
-  Observe the specifications for refueling.



Danger of poisoning

Fuel is poisonous and a health hazard.

- Avoid skin, eye and clothing contact with fuel.
- Immediately consult a doctor if you swallow fuel.
- Do not inhale fuel vapors.
- In case of skin contact, rinse the affected area with plenty of water.
- Rinse the eyes thoroughly with water, and consult a doctor in case of fuel contact with the eyes.
- Change your clothing in case of fuel spills on them.



Note : Material damage

Inadequate fuel quality causes the fuel filter to quickly become clogged.

- In some countries and regions, the available fuel quality and cleanliness may not be sufficient. This will result in problems with the fuel system.

Fuel > Super unleaded (ROZ 95/RON 95/PON 91)

Capacity > 6,5L (1,6US gal)

- Switch off the engine.
- Open the filler cap. ( . 29)
- Fill the fuel tank with fuel up to measurement A. Guideline
- Close the filler cap. ( . 29)

// 7. MAINTENANCE

7.1 Informations

Periodic inspection, adjustment, and lubrication will keep your vehicle in the safest and most efficient condition possible. Safety is an obligation of the vehicle owner/operator. The most important points of vehicle inspection, adjustment, and lubrication are explained on the following pages.

The intervals given in the periodic maintenance charts should be simply considered as a general guide under normal riding conditions. However, depending on the weather, terrain, geo-graphical location, and individual use, the maintenance intervals may need to be shortened.



Failure to properly maintain the vehicle or performing maintenance activities incorrectly may increase your risk of injury or death during service or while using the vehicle. If you are not familiar with vehicle service, have a Apollo dealer perform service.



Turn off the engine when performing maintenance unless otherwise specified.

- A running engine has moving parts that can catch on body parts or clothing and electrical parts that can cause shocks or fires.
- Running the engine while servicing can lead to eye injury, burns, fire, or carbon monoxide poisoning – possibly leading to death. See page .21 for more information about carbon monoxide.



Brake discs, calipers, drums, and linings can become very hot during use. To avoid possible burns, let brake components cool before touching them.

Emission controls not only function to ensure cleaner air, but are also vital to proper engine operation and maximum performance. In the following periodic maintenance charts, the services related to emissions control are grouped separately. These services require specialized data, knowledge, and equipment. Maintenance, replacement, or repair of the emission control devices and systems may be performed by any repair establishment or individual that is certified (if applicable). APOLLO dealers are trained and equipped to perform these particular services.

7.2 Owner's tool kit

The service information included in this manual and the tools provided in the owner's tool kit are intended to assist you in the performance of preventive maintenance and minor repairs. However, additional tools such as a torque wrench may be necessary to perform certain maintenance work correctly.

NOTE :

If you do not have the tools or experience required for a particular job, have a Apollo dealer perform it for you.

7.3 Periodic maintenance and adjustment

N	ÉLÉMENTS	CONTROLS OR MAINTENANCE TO BE CARRIED OUT	1 MONTH OR ONCE AFTER 10 HOURS	3 MONTHS OR EVERY 20 HOURS	6 MONTHS OR EVERY 40 HOURS	12 MONTHS OR EVERY 80 HOURS
1	Spark plug	<ul style="list-style-type: none"> ▪ Check condition. ↳ Adjust gap and clean. ↳ Replace if necessary. 	✓	✓	✓	
2	Air filter element	<ul style="list-style-type: none"> ▪ Clean with solvent. ↳ Replace if necessary. 		✓	✓	
3	Fuel line	<ul style="list-style-type: none"> ▪ Check fuel hoses for cracks or damage. ↳ Replace if necessary. 	✓	✓	✓	
4	Carburetor	<ul style="list-style-type: none"> ▪ Check engine idling speed and starter operation. ↳ Adjust if necessary. ▪ Clean. 		✓	✓	✓
5	Exhaust system	<ul style="list-style-type: none"> ▪ Check for head cylinder leakage . ↳ Tighten if necessary. ↳ Decarbonize if necessary. 		✓	✓	
6	Brakes	<ul style="list-style-type: none"> ▪ Check the front and rear brake linings. (📖.52) ▪ Check the brake discs. (📖.49) ▪ Check the brake lines for damage and leakage. ▪ Change the foot brake cylinder seals. ▪ Check the front and rear brake fluid level. (📖.49) ▪ Check the free travel of the foot brake lever. (📖.53) ▪ Change the front and rear brake fluid. (📖.50) 	✓ ✓ ✓ ✓ ✓ ✓	✓ ✓ ✓ ✓ ✓ ✓	✓ ✓ ✓ ✓ ✓ ✓	✓
7	Frame and swingarm	<ul style="list-style-type: none"> ▪ Check the frame and swingarm. (📖.73) ▪ Check the swingarm bearing. (📖.73) ▪ Grease all moving parts (e.g., hand lever, chain, ...) and check for smooth operation. ▪ Check play of steering head bearing. (📖.63) ▪ Grease the steering head bearing. (📖.64) 	✓ ✓	✓ ✓ ✓ ✓	✓ ✓ ✓ ✓	✓
8	Wheels	<ul style="list-style-type: none"> ▪ Check the tire condition. (📖.56) ▪ Check the tire air pressure. (📖.57) ▪ Check the wheel bearing for play. ▪ Check the wheel hubs. ▪ Check the rim run-out. ▪ Check the spoke tension. (📖.57) 	✓ ✓ ✓ ✓ ✓	✓ ✓ ✓ ✓ ✓	✓ ✓ ✓ ✓ ✓	
9	Chain	<ul style="list-style-type: none"> ▪ Check the chain, rear sprocket, engine sprocket, and chain guide. (📖.71) ▪ Check the chain tension. (📖.70) 	✓ ✓	✓ ✓	✓ ✓	
10	Engine	<ul style="list-style-type: none"> ▪ Change the engine oil and oil filter and clean the oil screens. (p. 81) ▪ Check the valve clearance. ▪ Check the clutch. ▪ Perform minor engine service, engine has been installed. (Change spark plug and spark plug connector. Change piston, check and measure cylinder; check cylinder head. Check the camshaft, rocker arm and rocker arm shafts. Check timing assembly.) ▪ Perform major engine service including removing and installing engine. (Change valves, valve springs, valve spring seats and valve spring retainers. Change the connecting rod, conrod bearing, and crank pin. ▪ Check the transmission and shift mechanism. Check the oil pressure regulator valve. Change the suction pump. Check the force pump and lubrication system. Change timing chain. Change all engine bearings. Change the shaft seal rings and bearing seals of the main bearing.) 	✓ ✓ ✓	✓ ✓	✓ ✓ ✓ ✓	✓

N	ÉLÉMENTS	CONTROLS OR MAINTENANCE TO BE CARRIED OUT	1 MONTH OR ONCE AFTER 10 HOURS	3 MONTHS OR EVERY 20 HOURS	6 MONTHS OR EVERY 40 HOURS	12 MONTHS OR EVERY 80 HOURS
11	Various	<ul style="list-style-type: none"> • Check all hoses (e.g. fuel, cooling, bleeder, drainage, etc.) and sleeves for cracking, leaks, and incorrect routing. • Check the cables for damage and routing without sharp bends. • Check that the throttle cables are undamaged, routed without sharp bends, and set correctly. • Check the screws and nuts for tightness. <p>Final check:</p> <ul style="list-style-type: none"> • Check the vehicle for safe operation and take a test ride. • Service the fork and the shock absorber 	✓	✓	✓	

Make the service entry in the Apollo dealer and in the Service and Warranty Booklet.

// 8. SUSPENSIONS

8.1 Informations



When adjusting the basic chassis setting, first adjust the shock absorber and then the fork

- For optimal motorcycle riding characteristics and to avoid damage to forks, shock absorbers, swingarm and frame, the basic settings of the suspension components must match the rider's weight.
- As delivered, Apollo are adjusted for an average rider's weight (with full protective clothing).

Guideline

Standard rider weight > 75... 85 kg (165... 187 lb.)

If the rider's weight is above or below this range, the basic setting of the suspension components must be adjusted accordingly.

Small weight differences can be compensated by adjusting the spring preload, but in the case of large weight differences, the springs must be replaced.

8.2 Changing the spring preloading of the shock absorber

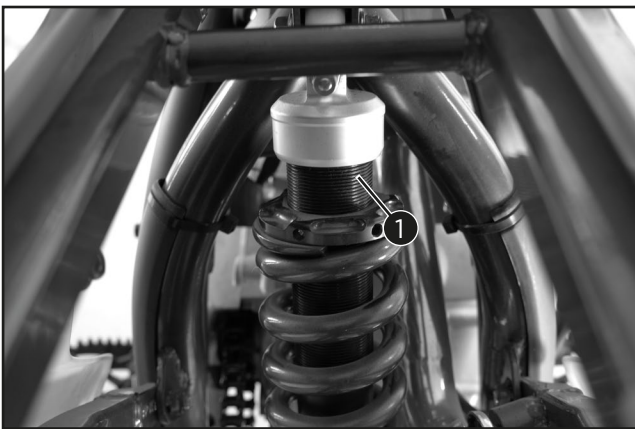

VOLT V-ONE (FREERIDE) / VOLT V-FORCE (ELITE)



V-TRAAK (FREERIDE S)

The spring preload can be changed by turning the adjusting ring 1. For this purpose, you should dismount the shock absorber and clean it thoroughly.

NOTE:

- Before changing the spring preload note down the basic setting, e.g. how many threads are visible above the adjusting ring.
- One rotation of the adjusting ring 1 changes the spring pretension by approximately 1.75 mm (0.07 in).

Loosen the clamping screw and use the hook wrench contained in the vehicle tool set to turn the adjusting ring as desired. Turning it counterclockwise will reduce the preload, turning it clockwise will increase the preload. After readjusting the clamping screw, tighten it to 5 Nm (6 ft.lb).

Basic suspension setup for the weight of the driver

To achieve maximum handling performance and to prevent the fork, shock absorber, swing arm and frame from being damaged, the basic setup of the suspension components must be suitable for your child's weight. At delivery, the fork and shock absorber are set to accommodate a driver weighing between 75 to 85 kg (165... 187 lb.) (wearing full protective clothing). If your child's weight exceeds or falls short of this range, you will need to adjust the spring components accordingly.

Minor deviations in weight can be compensated by adjusting the spring pre-load on the shock absorber. Other springs must be mounted on the fork and shock absorber for larger deviations.

Checking the shock absorber and spring

You can establish whether or not the shock absorber spring is suitable for your child's weight by checking the riding sag. The static sag must be correctly adjusted before the riding sag can be determined.

8.3 VOLT V-FORCE SHOCK ABSORBER (Freeride S 190 model only)

The VOLT V-FORCE rear shock absorber can only be adjusted by rebound.



Rebound damping function of the shock absorber.

By using the adjusting screw 4, the degree of damping of the rebound can be adjusted. Turn the knob clockwise to increase damping, turn it counter-clockwise to reduce damping during rebounding.

STANDARD ADJUSTMENT:

- Turn the adjusting screw clockwise to the stop.
- Then turn the adjusting screw counterclockwise, counting the number of clicks that corresponds to the respective type of shock absorber.



The damping unit of the shock absorber is filled with high-compression nitro-gen. Never try to take the shock absorber apart or to do any maintenance work yourself. Severe injuries could be the result.

8.4 VOLT V-TRAAK SHOCK ABSORBER (Freeride S option)

The VOLT V-TRAAK can be adjusted by compression high-speed, low-speed and by rebound damping.



Damping action during compression of shock absorber

The shock absorber on the models can synchronize the compression damping in the low and high-speed range separately (Dual Compression Control). Low and high speed refers to the movement of the shock absorber during compression and not to the speed of the motorcycle. The low and high-speed technology overlaps.

The low-speed setting is primarily for slow to normal shock absorber compression rates. The high-speed setting is effective at fast compression rates. Turning in a clockwise direction will increase the damping, turning counterclockwise will decrease the damping.

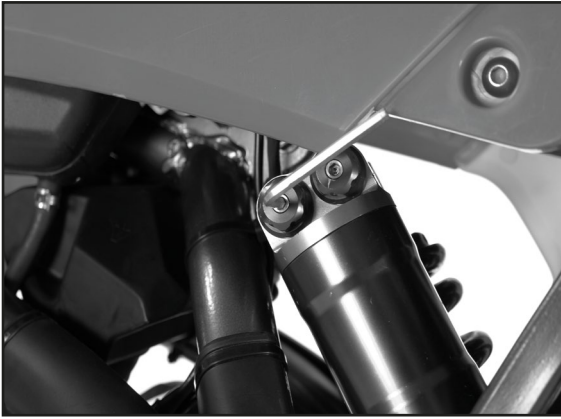

STANDARD LOW-SPEED SETTING:

- Turn the adjusting the left screw (blue) to the limit in a clockwise direction using a screwdriver
- Unscrew the respective number of clicks for the specific type of shock absorber in a counterclockwise direction.



STANDARD HIGH-SPEED SETTING:

- Turn the adjusting the right screw (black) to the limit in a clockwise direction using a screwdriver
- Unscrew the respective number of clicks for the specific type of shock absorber in a counterclockwise direction.

Rebound damping function of the shock absorber

By using the adjusting screw 1 the degree of damping of the rebound can be adjusted. Turn the knob clockwise to increase damping, turn it counter-clockwise to reduce damping during rebounding.



STANDARD ADJUSTMENT:

- Turn the adjusting screw clockwise to the stop.
- Then turn the adjusting screw counterclockwise, counting the number of clicks that corresponds to the respective type of shock absorber.



The damping unit of the shock absorber is filled with high-compression nitrogen. Never try to take the shock absorber apart or to do any maintenance work yourself. Severe injuries could be the result.

8.5 VOLT VTRAAK FRONT FORK (from Freeride S model)

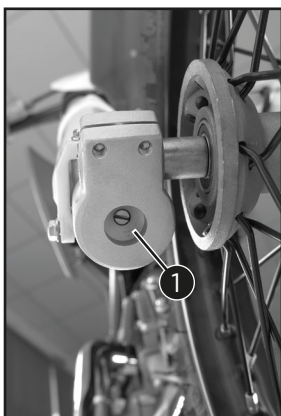

COMPRESSION DAMPING OF FORK:

Hydraulic compression damping determines the reaction when the fork is compressed. The degree of compression can be adjusted with adjusting screws at the bottom of the fork legs.

Turn the knob 1 clockwise to increase damping, turn it counterclockwise to reduce damping during compression.

STANDARD ADJUSTMENT:

- Turn adjusting screw clockwise as far as it will go
- Turn it back by as many clicks as are specified for the relevant type of fork



REBOUND DAMPING OF FORK:

Hydraulic rebound damping determines the reaction when the fork is rebound.

- By turning the adjusting screw 2, the degree of damping of the rebound can be adjusted.
- Turn the knob clockwise to increase damping, turn it counterclockwise to reduce damping during rebounding.

STANDARD ADJUSTMENT:

- Turn adjusting screw clockwise as far as it will go
- Turn it back by as many clicks as are specified for the relevant type of fork

8.6 Breather plug front fork



After every 5 hours of use for competitive racing, slacken the breather plugs 1 a few turns in order to relieve excess pressure from the inside of the fork. To do this, place the motorcycle on a stand with the front wheel lifted off the ground.



Excessive pressure in the interior of the fork can cause leaks in the fork. If your fork is leaking, it is recommended to open the breather plugs before having the seals replaced.

8.7 Cleaning the dust sleeves of the telescopic fork

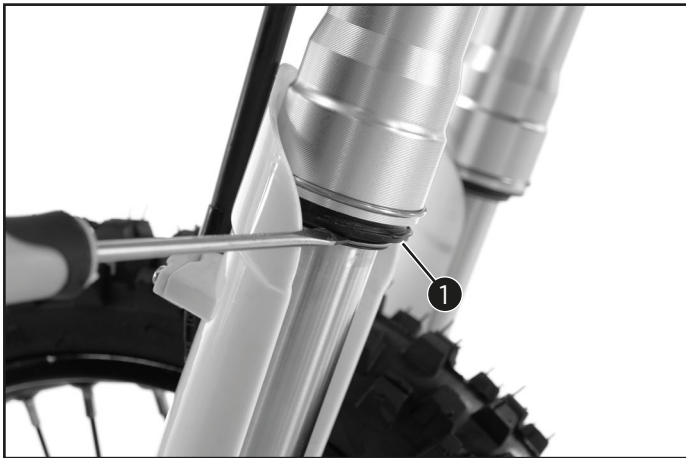

The dust-protection bellows 1 are to remove dust and coarse dirt particles from the fork tube. However, after some time, dirt may also get in behind the dust-protection bellows. If this dirt is not removed, the oil sealing rings located behind it may start to leak.

Use a screwdriver to lift the dust-protection bellows out of the outer tubes and slide them downward. Clean dust-protection bellows, outer tubes, and fork tubes thoroughly, and oil them thoroughly with oil-spray or engine oil. Then, push dust-protection bellows into the outer tubes by hand.



No oil may reach the front tire or the brake disks since this would considerably reduce the tire's road grip and the braking effect of the front brake.

8.8 How to change the handlebar position



The handlebar position can be readjusted (ELITE/ELITE S only). Thus, you can put the handlebar in the position that is the most convenient for you. The upper triple clamp includes bores arranged. Accordingly, you can mount the handlebar in different positions.

For this purpose, remove screws 1 of the handlebar clamps. Mount handlebar and handlebar clamps, and tighten screws 1 to 22 Nm. The gap between the handlebar support and handlebar clamps should be the same size in the front and in the rear.



The screws must be secured with a thread locker (Loctite).

// 9. BRAKE SYSTEM

9.1 Checking the brake discs



Danger of accidents

Worn-out brake discs reduce the braking effect.

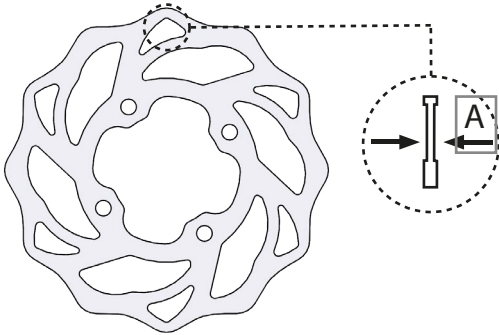

- Make sure that worn-out brake discs are replaced immediately. (Your authorized Apollo workshop will be glad to help.)
- Check the thickness of the front and rear brake discs at multiple points on each brake disc to ensure it is at least thickness A.



Wear reduces the thickness of the brake disc around the area used by the brake linings.

Brake discs - wear limit

Front 2.5 mm (0.098 in)

Rear 3.5 mm (0.138 in)

If the brake disc thickness is less than the specified value:

- Change the front brake discs.
- Change the rear brake disc.

Check the front and rear brake discs for damage, cracking, and deformation.

If the brake disc exhibits damage, cracking, or deformation:

- Change the front brake discs.
- Change the rear brake disc.

9.2 Checking the brake fluid level of the front and rear brakes



Danger of accidents

LA n insufficient brake fluid level will cause the brake system to fail.

If the brake fluid level drops below the specified marking or the specified value, the brake system is leaking or the brake linings are worn down.

- Check the brake system and do not continue riding until the problem is eliminated. (Your authorized Apollo workshop will be glad to help.)



Danger of accidents

Old brake fluid reduces the braking effect.

- Make sure that brake fluid for the front and rear brake is changed in accordance with the service schedule. (Your authorized Apollo workshop will be glad to help.)

Preparatory work

Check the front and rear brake linings. (📖.52)

Main work

- Move the brake fluid reservoir to a horizontal position.
- Check the brake fluid level in removing de cover.

If the brake fluid level has dropped below marking:

- Add front brake fluid. (📖.49)

9.3 Adding front and rear brake fluid



Danger of accidents

An insufficient brake fluid level will cause the brake system to fail.

If the brake fluid level drops below the specified marking or the specified value, the brake system is leaking or the brake linings are worn down.

- Check the brake system and do not continue riding until the problem is eliminated. (Your authorized Apollo workshop will be glad to help.)



Skin irritation

Brake fluid causes skin irritation.

- Keep brake fluid out of the reach of children.
- Wear suitable protective clothing and safety glasses.
- Do not allow brake fluid to come into contact with the skin, the eyes or clothing.
- Consult a doctor immediately if brake fluid has been swallowed.
- Rinse the affected area with plenty of water in the event of contact with the skin.
- Rinse eyes thoroughly with water immediately and consult a doctor if brake fluid comes into contact with the eyes.
- If brake fluid spills on to your clothing, change the clothing.



Danger of accidents

Old brake fluid reduces the braking effect.

- Make sure that brake fluid for the front and rear brake is changed in accordance with the service schedule. (Your authorized Apollo workshop will be glad to help.)



Environmental hazard

Hazardous substances cause environmental damage.

- Dispose of oils, grease, filters, fuel, cleaning agents, brake fluid, etc., correctly and in compliance with the applicable regulations



Never use DOT 5 brake fluid. It is silicone-based and purple in color. Oil seals and brake lines are not designed for DOT 5 brake fluid.

Avoid contact between brake fluid and painted parts. Brake fluid attacks paint.
Only use clean brake fluid from a sealed container.

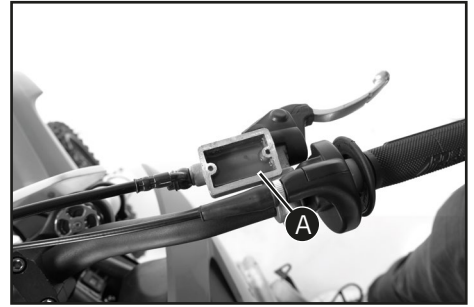
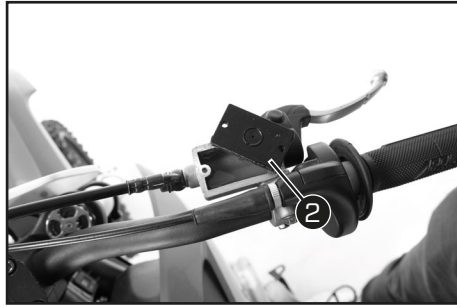
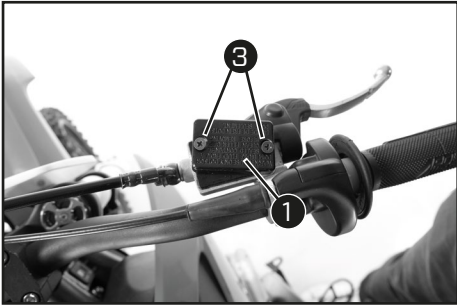

Preparatory work

- Check the front brake linings. ( .52)

Main work

- Move the brake fluid reservoir to a horizontal position.
- Remove screws 3.
- Remove cover 1 with membrane 2.

Add brake fluid to level A.

Guideline

Level A (brake fluid level below reservoir rim)

Brake fluid DOT 4 / DOT 5.1

Position cover 1 with membrane 2. Mount and tighten screws 3.



Clean up overflowed or spilled brake fluid immediately with water.

9.4 Checking the front and rear brake linings



Danger of accidents

Worn-out brake linings reduce the braking effect.

- Ensure that worn-out brake linings are replaced immediately. (Your authorized Apollo workshop will be glad to help.)

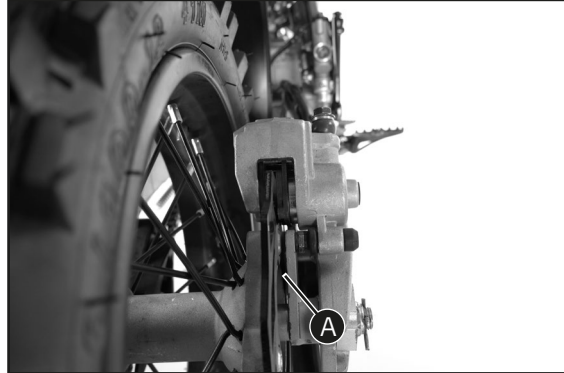

- Check the brake linings for minimum thickness A.

Minimum thickness $A \geq 1 \text{ mm}$ ($\geq 0.04 \text{ in}$)

If the minimum thickness is less than specified:

- Change the front brake linings. ( .52)
- Check the brake linings for damage and cracking.

If damage or cracking is visible:

- Change the front brake linings. ( .52)

9.5 Changing the front and rear brake linings

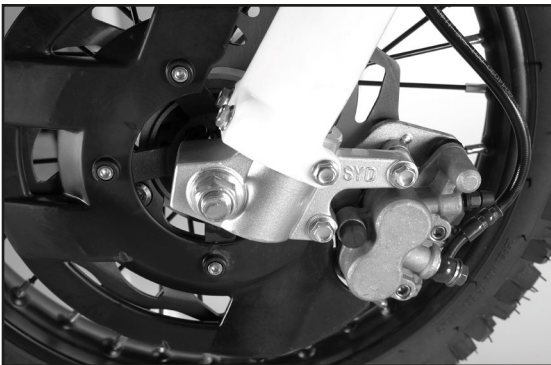

- Manually press the brake caliper toward the brake disc to push back the brake pistons. Ensure that brake fluid does not flow out of the brake fluid reservoir, if necessary extract excess.



Make sure that you do not press the brake caliper against the spokes when pushing back the brake pistons.

- Remove cotter pins, pull out pin, and remove the brake linings.



- Clean the brake caliper and brake caliper support.

- Check that leaf spring in the brake caliper and sliding plate in the brake caliper support are seated correctly.



- Insert the new brake linings, insert pin, and mount cotter pins.



Always change the brake linings in pairs.

- Operate the hand brake lever repeatedly until the brake linings are in contact with the brake disc and there is a pressure point.

- Add brake fluid up to the level. ( .50)

9.6 Adjusting the basic position of the foot brake lever



Danger of accidents

The brake system fails in the event of overheating.

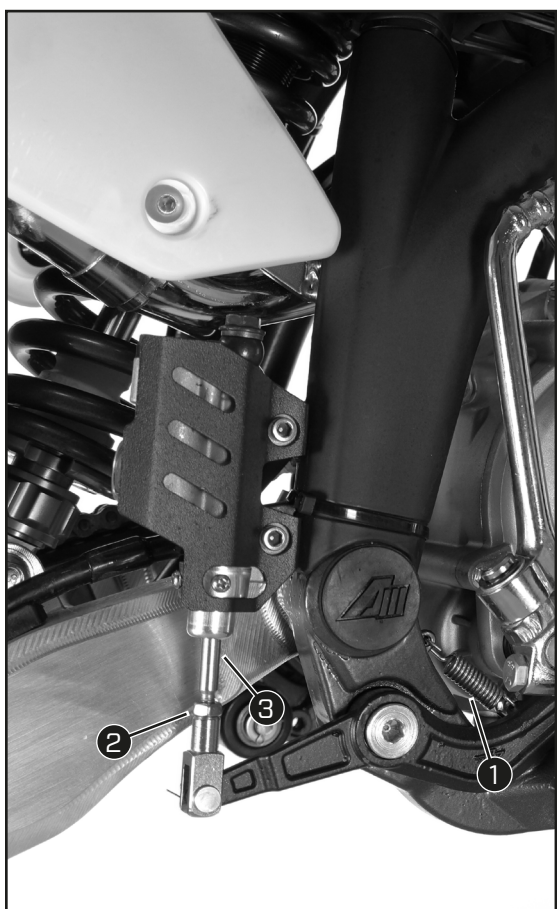

If there is no free travel on the foot brake lever, pressure builds up in the brake system on the rear brake.

- Set the free travel on the foot brake lever in accordance with the specification.
- Detach spring 1.
- Loosen nut 2 and, with push rod 3, turn it back until you have maximum free travel.
- To adjust the basic position of the foot brake lever to individual requirements.



The range of adjustment is limited.

- Turn push rod 3 accordingly until you have free travel. If necessary, adjust the basic position of the foot brake lever.

Guideline :

Free travel at foot brake lever 3... 5 mm (0.12... 0.2 in)

- Hold push rod 3 and tighten nut 2.

10.1 Removing the front wheel



Preparatory work

Raise the motorcycle with a lift stand.

Main work

Press the brake caliper onto the brake disc by hand in order to push back the brake pistons.



Make sure that you do not press the brake caliper against the spokes when pushing back the brake pistons.

- Remove nut 1.
- Loosen screws 2 (ELITE models only)
- Press on screw 4 to push the wheel spindle out of the axle clamp.
- Remove screw 4.

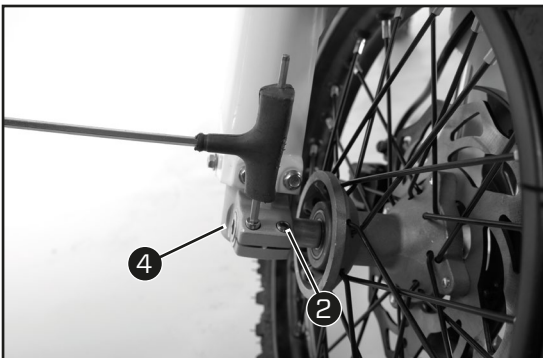

Holding the front wheel, withdraw the wheel spindle. Take the front wheel out of the fork.



Do not pull the hand brake lever when the front wheel is removed.

- Remove spacers 3.



10.2 Installing the front wheel



Danger of accidents

Oil or grease on the brake discs reduces the braking effect.

- Always keep the brake discs free of oil and grease.
- Clean the brake discs with brake cleaner when necessary.

Check the wheel bearing for damage and wear.

If the wheel bearing is damaged or worn:

- Change the front wheel bearing.
- Insert the spacers, the longest one must be on the disc side.
- Position the front wheel and insert the wheel spindle who must greased.
- Tighten nut 1

The brake linings are correctly positioned.

Mount and tighten screw 4.

Guideline

Nut, front wheel spindle, M14 121Nm (89,2 lbf ft)

10.3 Removing the rear wheel

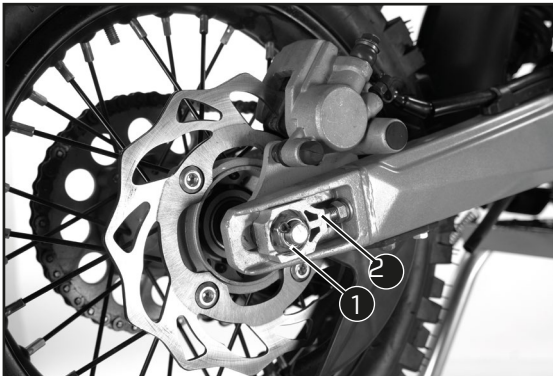

Preparatory work

Raise the motorcycle with a lift stand.

Main work

Press the brake caliper onto the brake disc by hand in order to push back the brake piston.



Make sure when pushing back the brake piston that you do not press the brake caliper against the spokes.

- Remove nut 1.
- Remove chain adjuster 2. Withdraw wheel spindle 3 only enough to allow the rear wheel to be pushed forward.
- Push the rear wheel forward as far as possible. Remove the chain from the rear sprocket

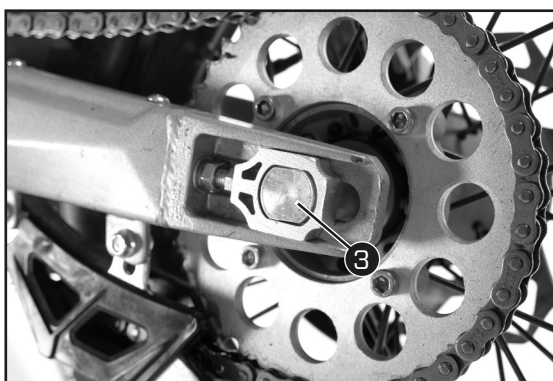

Cover the components to protect them against damage.



Danger of accidents

Damaged brake discs reduce the braking effect.

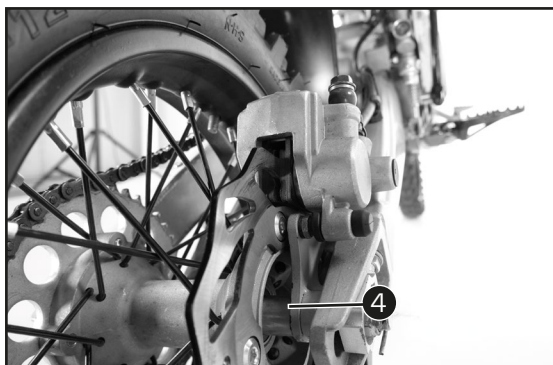

- Always lay the wheel down in such a way that the brake disc is not damaged
- Holding the rear wheel, withdraw the wheel spindle. Take the rear wheel out of the swingarm.



Do not operate the foot brake lever when the rear wheel is removed.

- Remove spacers 4.

10.4 Installing the rear wheel



Danger of accidents

Oil or grease on the brake discs reduces the braking effect.

- Always keep the brake discs free of oil and grease.
- Clean the brake discs with brake cleaner when necessary.

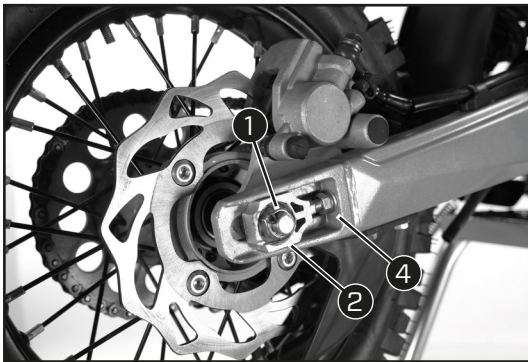
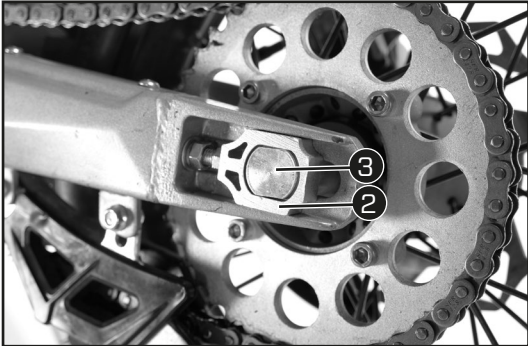

Main work

Check the wheel bearing for damage and wear.

If the wheel bearing is damaged or worn:

- Change the rear wheel bearing.
- Insert the spacers.
- Position the rear wheel and insert wheel spindle 3.
- Position chain adjuster 2. Mount nut 1, but do not tighten it yet.
- Make sure that chain adjusters 2 are fitted correctly on adjusting screws 4.
- Check the chain tension. (p. 57)
- Tighten nut 1.

Guideline

Nut, rear wheel spindle M14 121Nm (89,2 lbf ft)

- Operate the foot brake lever repeatedly until the brake linings are in contact with the brake disc and there is a pressure point.

10.5 Checking the tire condition



Only mount tires approved and/or recommended by Apollo. Other tires could have a negative effect on handling characteristics.

The type, condition, and air pressure of the tires all have a major impact on the handling of the motorcycle. The tires mounted on the front and rear wheels must have a similar profile.

Worn tires have a negative effect on handling characteristics, especially on wet surfaces.

- Check the front and rear tires for cuts, run-in objects, and other damage.

If the tires have cuts, run-in objects, or other damage:

- Change the tires.
- Check the tread depth.



Adhere to the legally required minimum tread depth.
Minimum tread depth ≥ 2 mm (≥ 0.08 in)

If the tread depth is less than the minimum tread depth:

- Change the tires.
- Check the tire age.



The tire date of manufacture is usually contained in the tire label and is indicated by the last four digits of the DOT number. The first two digits indicate the week of manufacture and the last two digits the year of manufacture.

APOLLO recommends that the tires be changed after 5 years at the latest, regardless of the actual state of wear.

If the tires are more than 5 years old:

- Change the tires.

10.6 Checking the tire air pressure



Low tire air pressure leads to abnormal wear and overheating of the tire.

Correct tire air pressure ensures optimal riding comfort and maximum tire service life.

- Remove the protection cap.
- Check the tire air pressure when the tires are cold.

Tire air pressure off road

Front 1.0 bar (15 psi)

Rear 1.0 bar (15 psi)

If the tire pressure does not meet specifications:

- Correct the tire pressure.
- Mount the protection cap.

10.7 Checking spoke tension



Danger of accidents

Incorrectly tensioned spokes impair the handling characteristic and result in secondary damage.

The spokes break due to being overloaded if they are too tightly tensioned. If the tension in the spokes is too low, then lateral and radial run-out will form in the wheel. Other spokes will become looser as a result.

- Check spoke tension regularly, and in particular on a new vehicle. (Your authorized Apollo workshop will be glad to help.) Strike each spoke briefly using a screwdriver blade.



The frequency of the sound depends on the spoke length and spoke diameter.

If you hear different tone frequencies from different spokes of equal length and diameter, this is an indication of different spoke tensions. **You should hear a high note.**

If the spoke tension differs:

- Correct the spoke tension.
- Check the spoke torque.

Guideline

Spoke nipple, front wheel M3,5 / 3 Nm (2,2 lbf ft)

Spoke nipple, rear wheel M3,5 / 3 Nm (2,2 lbf ft)

// 11. SERVICE WORK ON THE CHASSIS

11.1 Cleaning the dust boots of the fork legs



Preparatory work

Raise the motorcycle with a lift stand.

Remove the fork protector. (📖 .58)

Main work

Push dust boots 1 of both fork legs downward.



The dust boots remove dust and coarse dirt particles from the inside fork tubes. Over time, dirt can accumulate behind the dust boots. If this dirt is not removed, the shaft seal rings behind can start to leak.



Danger of accidents

Oil or grease on the brake discs reduces the braking effect.

- Always keep the brake discs free of oil and grease.
- Clean the brake discs with brake cleaner when necessary.

Nettoyer et lubrifier le cache-poussière et le tube intérieur de Fork des deux bras de Fork.

Universal oil spray

- Press the dust boots back into their normal position.
- Remove excess oil.

Finishing work

- Install the fork protector. (📖 .59)
- Remove the motorcycle from the lift stand.

11.2 Removing the fork protector

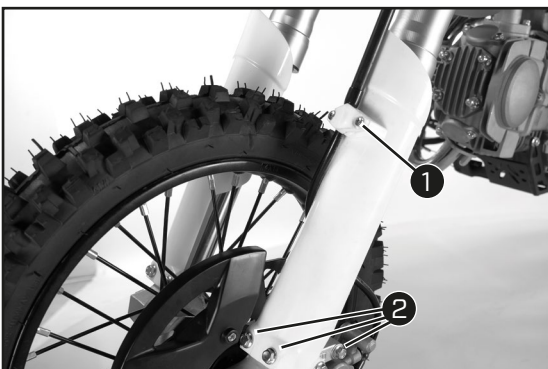

- Remove screws 1 and take off the clamp.
- Remove screws 2 on the left fork leg.
- Take off the fork protector.

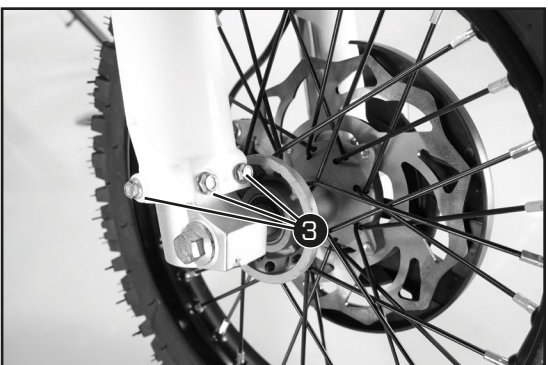

- Remove screws 3 on the right fork leg.
- Take off the fork protector.

11.3 Installing the fork protector



- Position the fork protector on the right fork leg.
- Mount and tighten screws 3.

Guideline

Remaining screws, chassis M6 5 Nm (3,6 lbf)

- Position the fork protector on the left fork leg.
- Mount and tighten screws 2.

Guideline

Remaining screws, chassis M6 5 Nm (3,6 lbf)

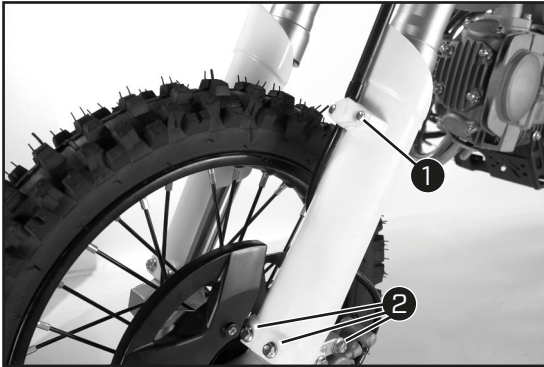

- Position the brake line and clamp.
- Mount and tighten screws 3.

11.4 Removing the fork legs

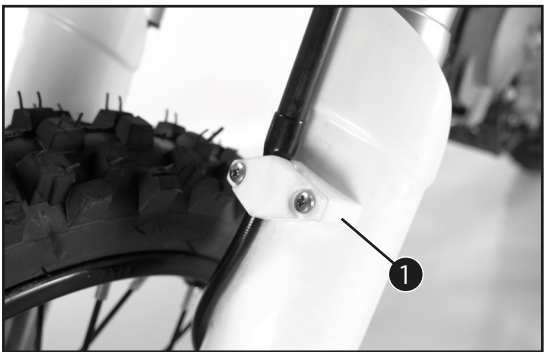

Preparatory work

- Raise the motorcycle with a lift stand.
- Remove the front wheel. (📖.54)

Main work

- Remove screws 1 and take off the clamp.
- Remove screws 2 and take off the brake caliper.
- Allow the brake caliper and brake line to hang loosely to the side.

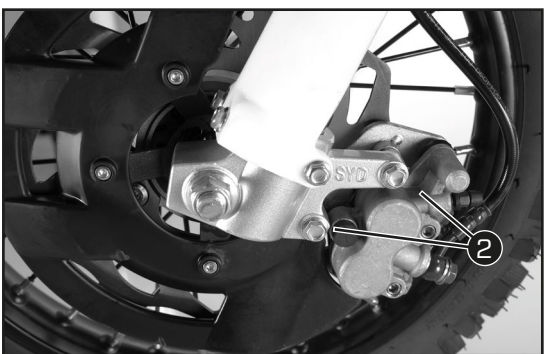

- Loosen screws 3. Take out the left fork leg.
- Loosen screws 4. Take out the right fork leg.

Elite

11.5 Installing the fork legs

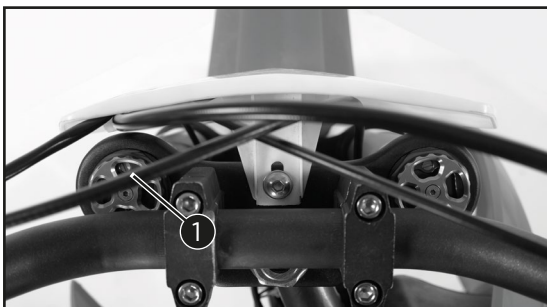

Main work

- Position the fork legs.

Bleeder screws 1 are positioned toward the front.



The second milled groove in the fork leg must be flush with the upper edge of the upper triple clamp.

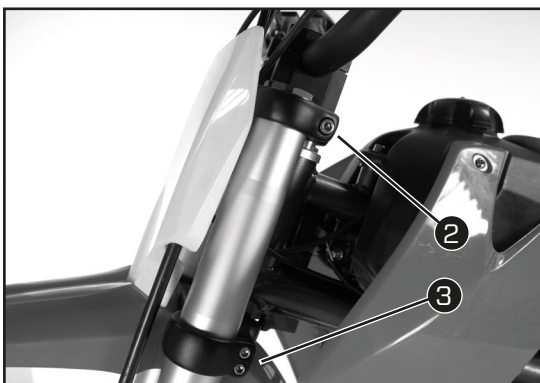

- Tighten screws 2.

Guideline

Screw, top triple clamp M8 20 Nm (14.8 lbf ft)

- Tighten screws 3.

Guideline

Screw, bottom triple clamp M8 20 Nm (14,8 lbf ft)

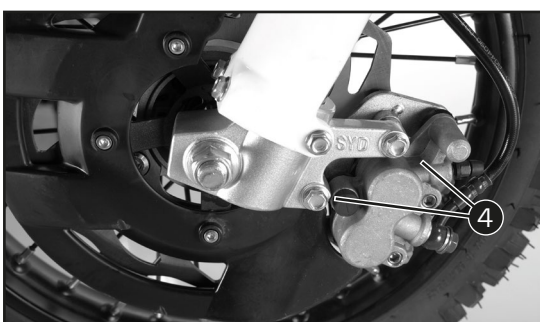

- Position the brake caliper, and mount and tighten screws 4.

Guideline

Screw, front brake caliper M6 10 Nm (7,3 lbf ft)

- Position the brake line and clamp.
- Mount and tighten screws 5.

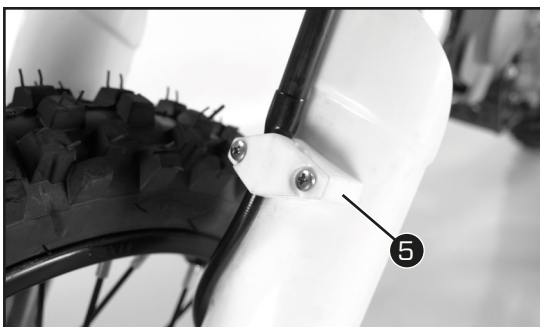

11.6 Removing the lower triple clamp

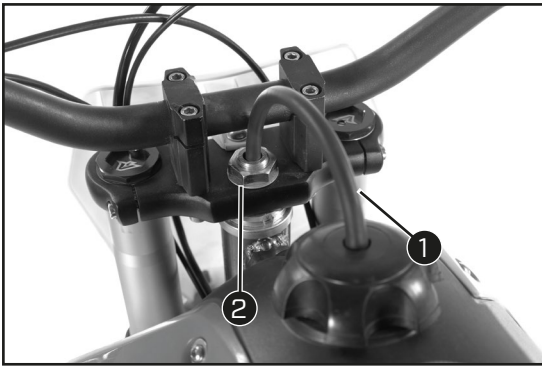

Preparatory work

- Raise the motorcycle with a lift stand.
- Remove the front wheel. (📖.54)
- Remove the fork legs. (📖.59)
- Remove the start number plate. (📖.64)
- Dismount the front fender. (📖.65)



Cover the components to protect them against damage. Do not kink the cables and lines.

Main work

- Remove protective ring.
- Remove the lower triple clamp with the steering stem.
- Take out the upper steering head bearing.

11.7 Installing the lower triple clamp

Main work

- Remove the fuel tube 1 out of the steering stem
- Remove the nut 3
- Take out the upper steering head bearing.
- Remove protective ring.
- Remove the lower triple clamp with the steering stem.

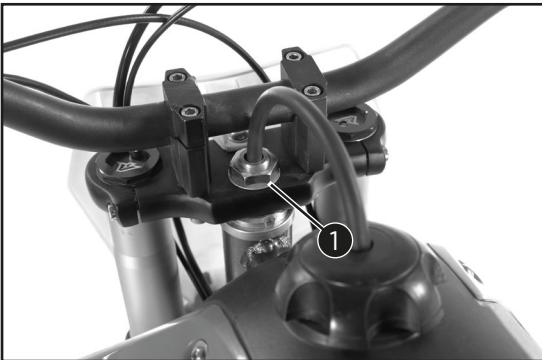

- Position the upper triple clamp with the handlebar.
- Mount nut 1, but do not tighten it yet.

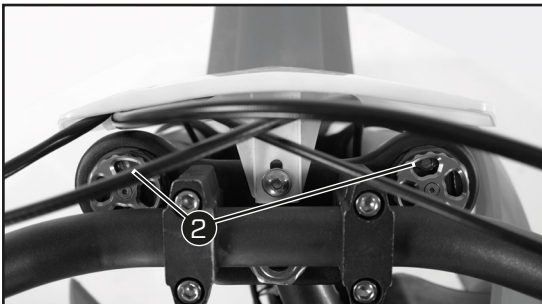

- Position the fork legs.
- Bleeder screws 2 are positioned toward the front.



The second milled groove in the fork leg must be flush with the upper edge of the upper triple clamp.

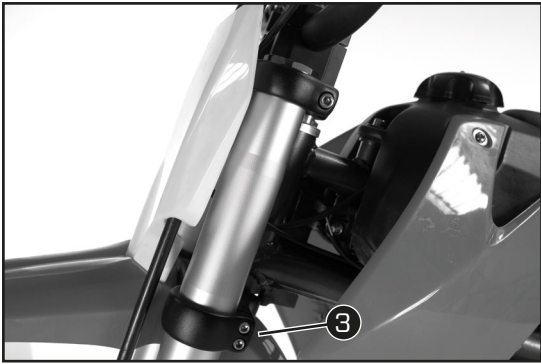

- Tighten screws 3.

Guideline

Screw, bottom triple clamp M8 20 Nm (14,8 lbf ft)

- Tighten nut 4 & 1

Guideline

Nut, steering head M22 64 Nm (47,2 lbf ft)

- Position the fuel tank breather 5 in the steering stem.
- Tighten screws 6

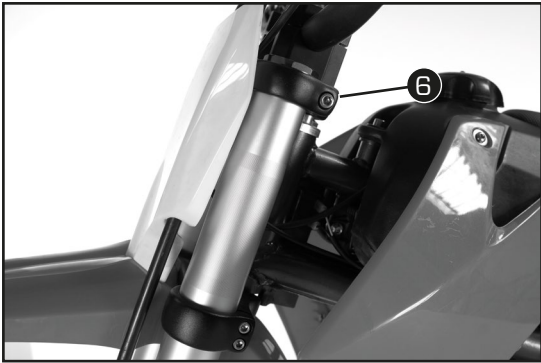

Guideline

Screw, top triple clamp M8 20 Nm (14.8 lbf ft)

- Position the brake caliper, and mount and tighten screws 6.

Guideline

Screw, front brake caliper M6 10 Nm (7,3 lbf ft)

- Position the brake line and clamp. Mount and tighten screws 7.

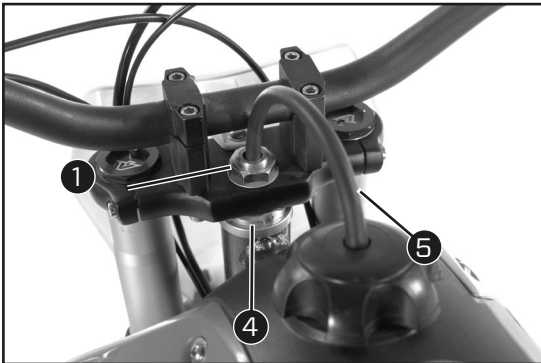

Finishing work

- Install the front fender. (📖.65)
- Install the start number plate. (📖.65)
- Check that the wiring harness, throttle cables, and brake and clutch lines can move freely and are routed correctly.
- Install the front wheel. (📖.54)
- Check play of steering head bearing. (📖.63)
- Remove the motorcycle from the lift stand.

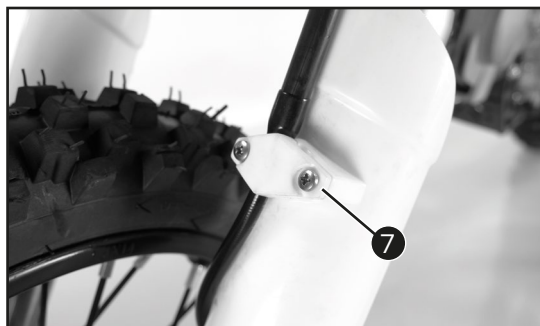
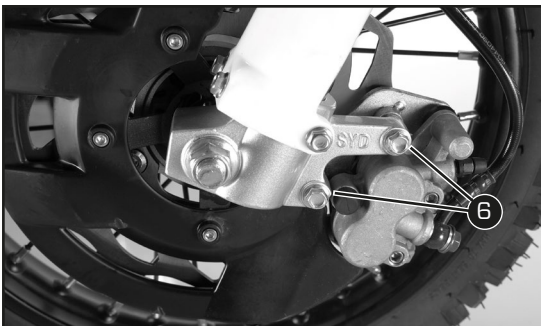
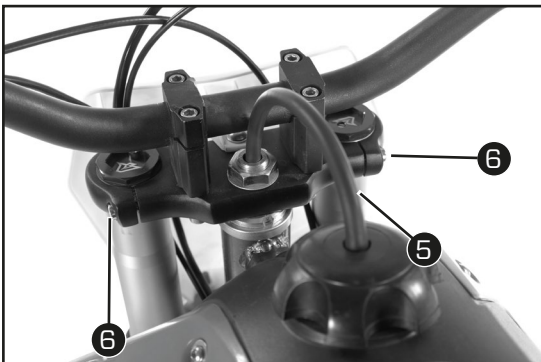

11.8 Checking play of steering head bearing



Danger of accidents

Incorrect steering head bearing play impairs the handling characteristic and damages components.

- Correct incorrect steering head bearing play immediately. (Your authorized Apollo workshop will be glad to help.)



If the bike is ridden with play in the steering head bearing, the bearing and the bearing seats in the frame can become damaged over time.



Preparatory work

- Raise the motorcycle with a lift stand.

Main work

- Move the handlebar to the straight-ahead position.
- Move the fork legs to and fro in the direction of travel.

No play should be noticeable in the steering head bearing.

If there is noticeable play present:

- Adjust the steering head bearing play. (📖.64)
- Move the handlebar to and fro over the entire steering range.

The handlebar must be able to move easily over the entire steering range. No resting locations should be noticeable.

If click positions are noticeable:

- Adjust the steering head bearing play. (📖.64)
- Check the steering head bearing and replace if required.

Finishing work

- Remove the motorcycle from the lift stand.

11.9 Adjusting the steering head bearing play

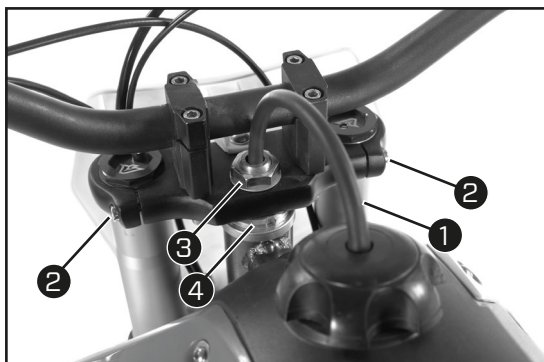

Preparatory work

- Raise the motorcycle with a lift stand.

Main work

- Pull fuel tank breather 1 out of the steering stem.
- Loosen screws 2.
- Loosen nut 3.

Guideline

Nut, steering head M22 64 Nm (47,2 lbf ft)

- Using a plastic hammer, tap lightly on the upper triple clamp to avoid stresses.
- Tighten screws 4.

Guideline

Screw, top triple clamp M8 20 Nm (14.8 lbf ft)

- Tighten screws 2
- Tighten nut 3

Guideline

Screw, top triple clamp M8 20 Nm (14.8 lbf ft)

11.10 Greasing the steering head bearing

- Remove the lower triple clamp. (📖.61)
- Install the lower triple clamp. (📖.61)

11.11 Removing the start number plate



- Remove screw 1.
- Unhook the start number plate from the brake line and remove it.



11.12 Installing the start number plate

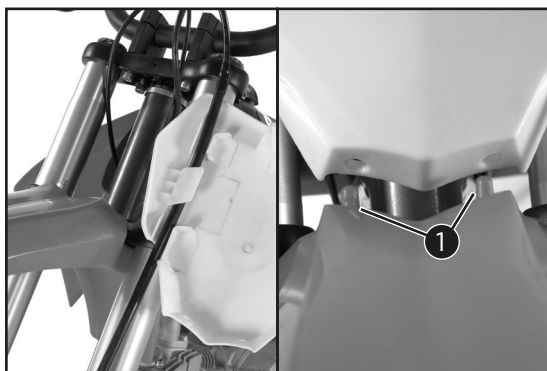

- Attach the start number plate to the brake line.
- Position the start number plate.
- Holding lugs 1 engage in the fender.

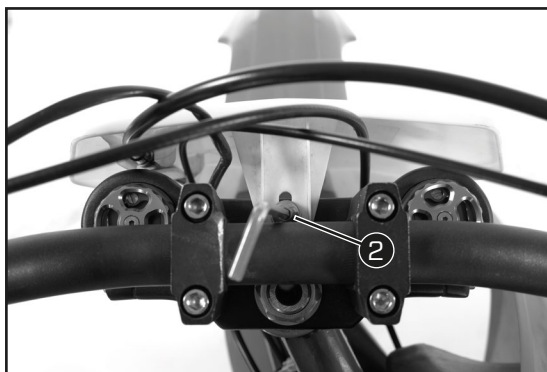

- Mount and tighten screw 2.

Guideline

Screw, start number plate M6 4 Nm (3 lbf ft)

11.13 Dismounting the front fender

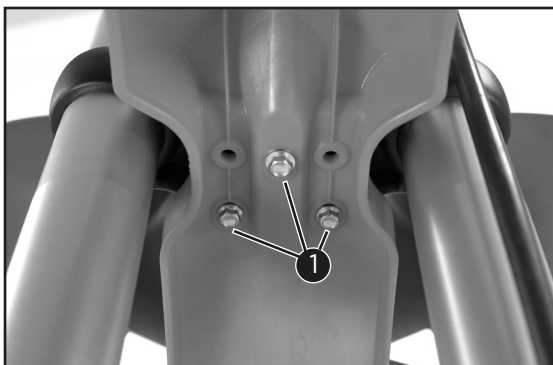

- Remove screws 1.
- Remove the front fender.

11.14 Installing the front fender

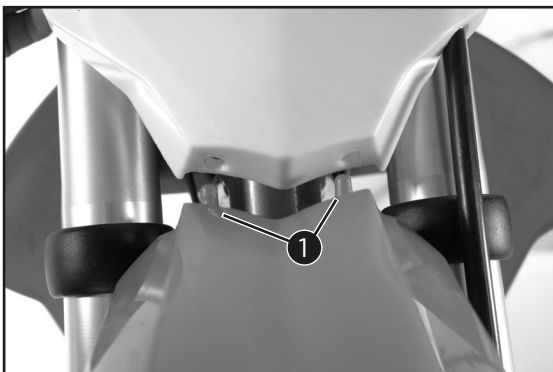

- Position the fender with drill holes 1 in the holding lugs on the start number plate.

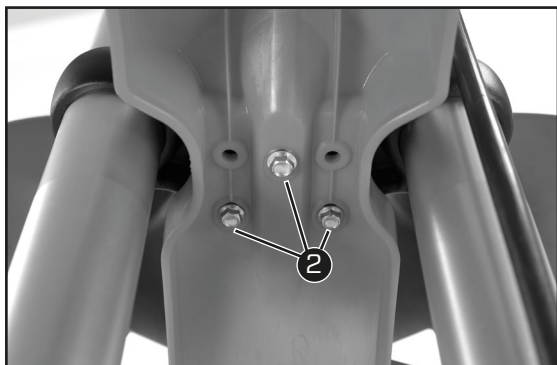

- Position the front fender.
- Mount and tighten screws 2.

Guideline

Screw, fender M6 4 Nm (3 lbf ft)

11.15 Removing the shock absorber

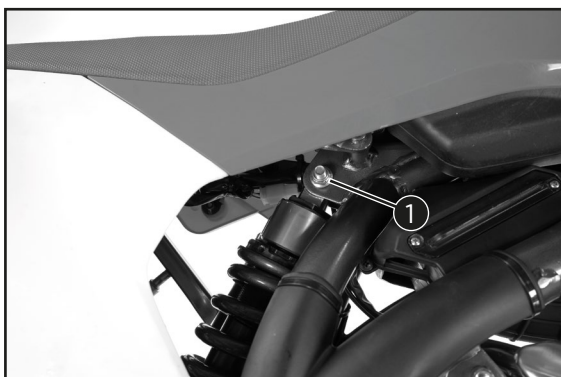

Preparatory work

- Raise the motorcycle with a lift stand.
- Remove nut 1 and 5.

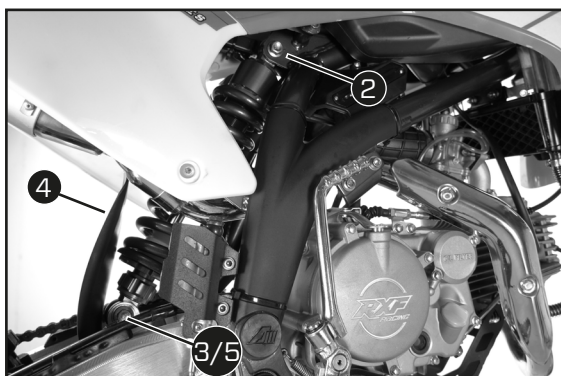

- Remove screw 3; lower the rear wheel with the swingarm as far as possible without blocking the rear wheel. Secure the rear wheel in this position.
- Remove screw 2, push splash protector 4 to the side, and remove the shock absorber.

11.16 Installing the shock absorber



Danger of accidents

Modifications to the suspension settings can seriously alter the vehicle's ride behavior.

- Following modifications, ride slowly at first to get the feel of the new ride behavior.

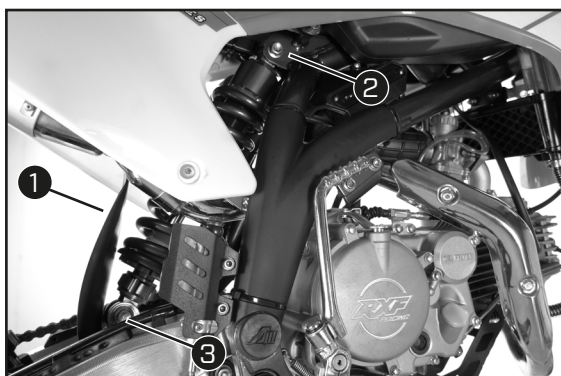

Main work

- Push splash protector 1 to the side.
- Mount the screw 2
- Raise the swingarm; position the shock absorber with screw 3.

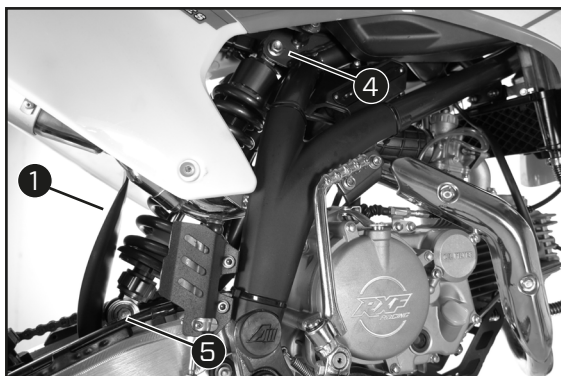

- Mount nut 4 and tighten fitting.

Guideline

Screw, top shock absorber M10 45 Nm(33.2 lbf ft)

- Mount nut 5 and tighten fitting.

Guideline

Screw, bottom shock absorber M10 45 Nm(33.2 lbf ft)

- Install the rear wheel. ( .56)

Finishing work

- Remove the motorcycle from the lift stand.

11.17 Removing the seat



- Remove the screw 1 bellow the seat

11.18 Mounting the seat



- Hook the seat onto screw 1, lower the seat at the rear, and push it forward.
- Catch 2 hooks into the fuel tank.



- Tighten the screw 3

11.19 Removing the air filter



Dommages sur le moteur

Unfiltered intake air has a negative effect on the service life of the engine. Dust and dirt will enter the engine without an air filter.

- Never start to use the vehicle without an air filter.



- Remove the screws 1 from the box in air, then pull the drawer to access the air filter.
- Take off the air filter.

11.20 Washing and installing the air filter



Main work

- Position the clean air filter.
- Close the drawer in the air box and tighten the screws 1



Do not clean the air filter with fuel or petroleum since these substances attack the foam. Wash the air filter thoroughly in special cleaning liquid and allow it to dry properly.

Only press the air filter to dry it, never wring it out.

11.21 Removing the engine sprocket cover

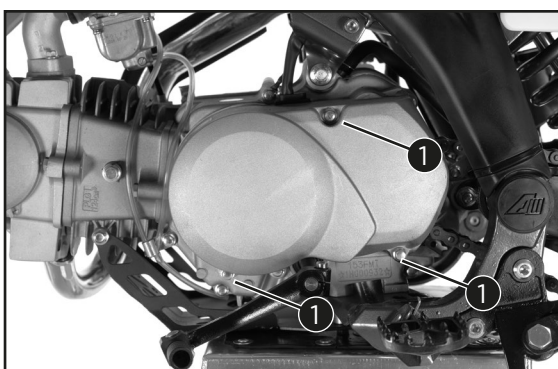

Preparatory work

- Raise the motorcycle with a lift stand.

Main work

- Remove screws 1.
- Take off the engine sprocket cover.

11.22 Installing the engine sprocket cover

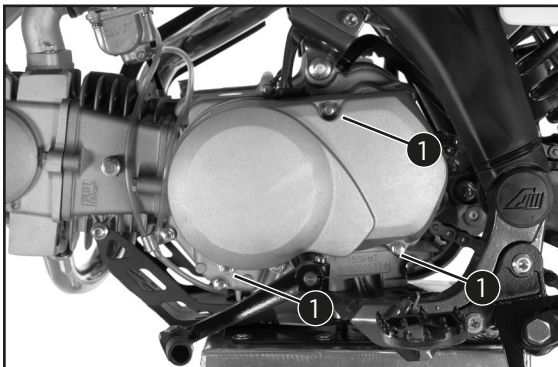

Main work

- Position the engine sprocket cover.
- Mount screws 1 but do not tighten yet.

Guideline

Screw, engine sprocket cover M8 12 Nm (8.9 lbf ft)

- Tighten screws 1.

Guideline

Screw, engine sprocket cover M6 10 Nm (7.4 lbf ft)

11.23 Checking and cleaning the chain for dirt

- Check the chain for coarse dirt accumulation.
- Clean If the chain is very dirty.



Danger of accidents

Oil or grease on the tires reduces the road grip.

- Remove the lubricant from the tires using a suitable cleaning agent.



Danger of accidents

Oil or grease on the brake discs reduces the braking effect.

- Always keep the brake discs free of oil and grease.
- Clean the brake discs with brake cleaner when necessary.



Environmental hazard

Hazardous substances cause environmental damage.



The service life of the chain depends largely on its maintenance.

Preparatory work

- Raise the motorcycle with a lift stand.

Main work

- Clean the chain regularly and then treat with chain spray.

11.24 Checking the chain tension



Danger of accidents

Incorrect chain tension damages components and results in accidents.

If the chain is tensioned too much, the chain, engine sprocket, rear sprocket, transmission and rear wheel bearings wear more quickly. Some components may break if overloaded.

If the chain is too loose, the chain may fall off the engine sprocket or the rear sprocket. As a result, the rear wheel locks or the engine will be damaged.

- Check the chain tension regularly.
- Set the chain tension in accordance with the specification.

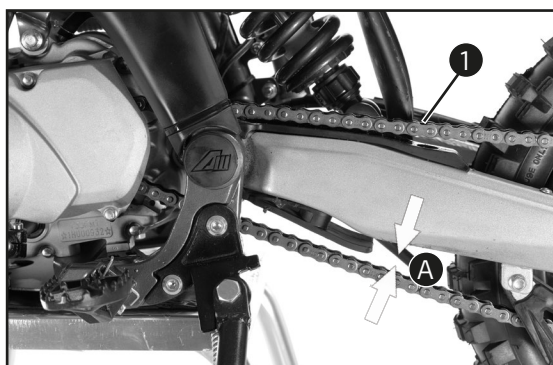

Preparatory work

- Raise the motorcycle with a lift stand.

Main work

- Press the chain upward at the end of the chain sliding piece and determine chain tension A.

Guideline

Chain Tension 15...25mm (0,6..0,9 in)

Chain wear is not always even, so you should repeat this measurement at different chain positions.



The upper part of the chain 1 must be taut.

Guideline

Chain tension 15...25mm (0,6..0,9 in)

If the chain tension does not meet the specification:

- Adjust the chain tension. (📖.70)

11.25 Adjusting the chain tension



Danger of accidents

Incorrect chain tension damages components and results in accidents.

If the chain is tensioned too much, the chain, engine sprocket, rear sprocket, transmission and rear wheel bearings wear more quickly. Some components may break if overloaded.

If the chain is too loose, the chain may fall off the engine sprocket or the rear sprocket. As a result, the rear wheel locks or the engine will be damaged.

- Check the chain tension regularly.
- Set the chain tension in accordance with the specification.

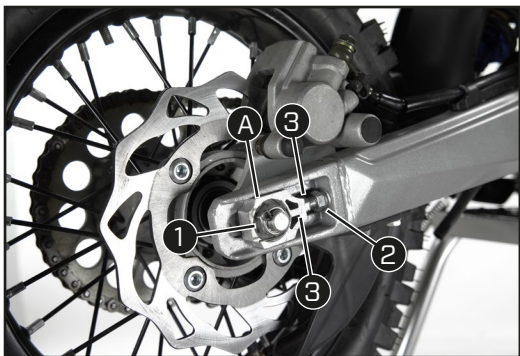

Preparatory work

- Raise the motorcycle with a lift stand.
- Check the chain tension. (📖.70)

Main work

- Loosen nut 1.
- Loosen nuts 2.
- Adjust the chain tension by turning adjusting screws 3 left and right.

Guideline

Chain tension 15...25mm (0,6..0,9 in)

- Tighten nuts 2.
- Make sure that chain adjusters 4 are fitted correctly on adjusting screws 3.
- Tighten nut 1.

Guideline

Nut, rear wheel spindle M14 120 Nm (88,5 lbf ft)

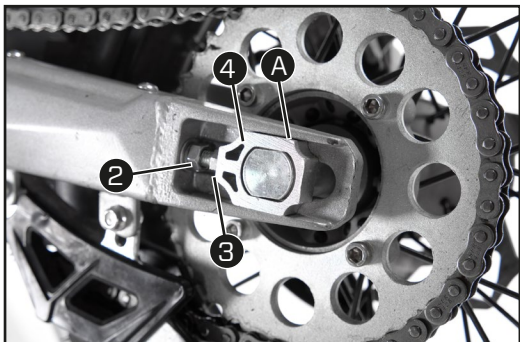

11.26 Checking the chain, rear sprocket, engine sprocket, and chain guide

Preparatory work

- Raise the motorcycle with a lift stand.

Main work

- Shift the transmission to idle.
- Check the rear sprocket and engine sprocket for wear.

If the rear sprocket or engine sprocket is worn:

- Change the drivetrain kit.



The engine sprocket, rear sprocket, and chain should always be replaced together.

- Check the chain for wear.

If the chain is worn:

- Change the drivetrain kit.



When a new chain is mounted, the rear sprocket and engine sprocket should also be changed.

New chains wear out faster on old, worn sprockets.

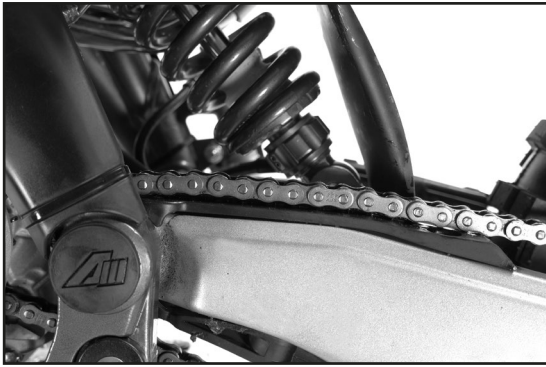

- Check the chain sliding guard for wear.

If the lower edge of the chain pins is in line with or below the chain sliding guard:

- Change the chain sliding guard.
- Check that the chain sliding guard is firmly seated.

If the chain sliding guard is loose:

- Tighten the screws on the chain sliding guard.

Guideline

Upper Screw, chain sliding guard M8 15 Nm (11,1 lbf ft)

Bottom screw, chain sliding guard M8 15 Nm (11,1 lbf ft)

Check the chain guide with a slide gauge for dimension.

Minimum thickness of the chain guide 6 mm (0.24 in)

If the measured value is less than the specification:

- Change the chain guide.



Check that the chain guide is firmly seated.

If the chain guide is loose:

Tighten the screws on the chain guide.

Guideline

Remaining screws, chassis M6 6 Nm (4,4 lbf ft)

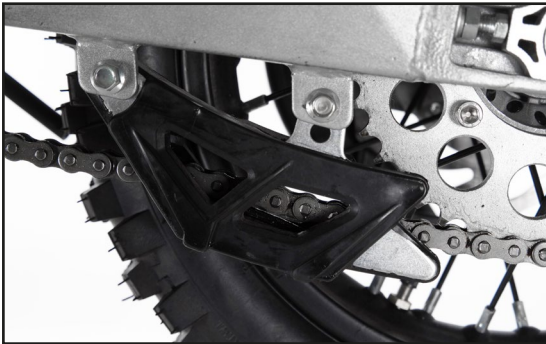

11.27 Checking the frame

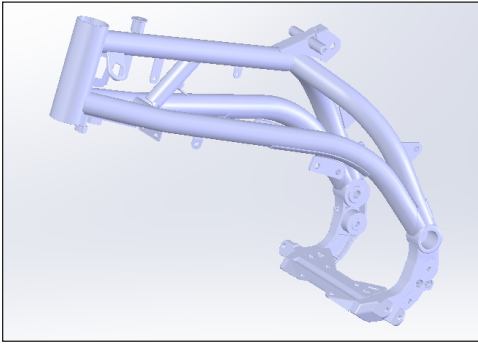

- Check the frame for cracks and deformation.

If the frame exhibits cracks or deformation due to a mechanical impact:

- Change the frame.



Always replace a frame that has been damaged due to a mechanical impact. Repair of the frame is not authorized by Apollo.

11.28 Checking the swingarm

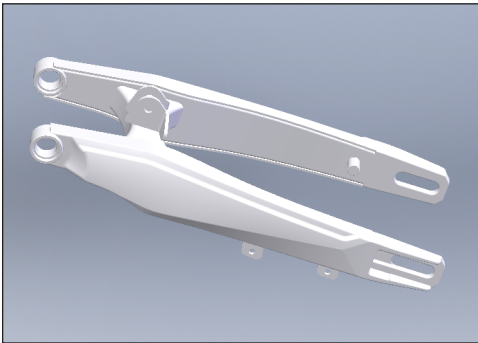

Check the swingarm for damage, cracking, and deformation.

If the swingarm shows signs of damage, cracking, or deformation:

- Change the swingarm.



Always change a damaged swingarm. Repair of the swingarm is not authorized by Apollo.

11.29 Checking the throttle cable routing



Danger of accidents

The throttle cable may slip out of the guide if routed incorrectly.

The throttle slide will then no longer be closed and the speed can no longer be controlled.

- Make sure that the throttle cable routing and the play in throttle cable complies with the specification.

Preparatory work

Turn the knurled screw on the fuel tap all the way clockwise.

Main work

Check the throttle cable routing.

The throttle cable must be routed to the carburetor between the handle bar and the start number plate, then between the left front fork and the steering stem.

If the throttle cable is not routed as specified:

- Correct the throttle cable routing.

11.30 Checking the rubber grip

- Check the rubber grips on the handlebar for damage, wear, and looseness.

If a rubber grip is damaged, worn, or loose:

- Change and secure the rubber grip.

11.31 Additionally securing the rubber grip

Preparatory work

- Check the rubber grip (.74).

Main work

- Secure the rubber grip at two locations with the retaining wire.
- The twisted wire ends face away from the palms and are bent in toward the rubber grip.

12.1 Checking the play of the throttle cable



- Check the throttle grip for smooth operation.
- Move the handlebar to the straight-ahead position.
- Move the throttle grip back-wards and forwards to ascertain play in the throttle cable.

Play in gas throttle cable 3... 5 mm (0.12... 0.2 in)

If the throttle cable play does not meet specifications:

Adjust the play in the throttle cable. (📖.75)

Danger d'intoxication

Exhaust gases are toxic and inhaling them may result in unconsciousness and death.

- 🚫 Always make sure there is sufficient ventilation when running the engine.
- 🚫 Use an effective exhaust extraction system when starting or running the engine in an enclosed space.

Start the engine and let it idle. Move the handlebar to and fro over the entire steering range. The idle speed should not change.

If the idle speed changes:

- Adjusting the play in the throttle cable. (📖.75)

12.2 Adjusting the play in the throttle cable

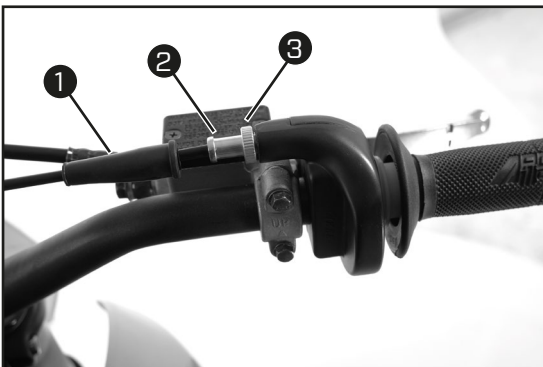

Preparatory work

- Turn the knurled screw on the fuel tap all the way clockwise.
- Remove the fuel tank.
- Check the throttle cable routing. (📖.73)

Main work

- Move the handlebar to the straight-ahead position.
- Push back sleeve 1.
Ensure that the throttle cable sleeve is pushed all the way into adjusting screw 2.
- Loosen nut 3.
- Turn adjusting screw 2 so that there is throttle cable play A at the throttle grip.

Play in gas throttle cable 3... 5 mm (0.12... 0.2 in)

- Tighten nut 3.
- Slide on sleeve 1.

Finishing work

- Install the fuel tank.
- Mount the seat. (📖.67)
- Check the play of the throttle cable. (📖.75)

12.3 Carburetor - idle

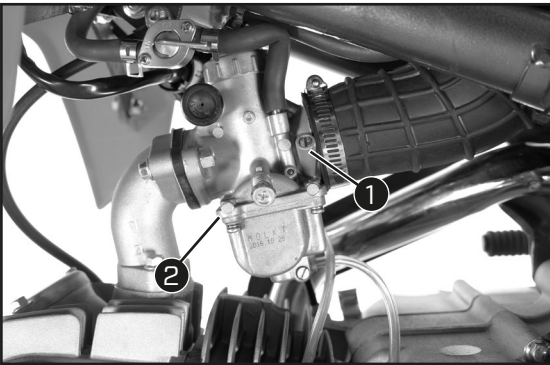

The idle setting of the carburetor has a big influence on the starting behavior, stable idling and the response to throttle opening. That means that an engine with a correctly set idle speed is easier to start than if the idle is set wrongly.



The carburetor and its components are subject to increased wear caused by engine vibration. Wear can result in malfunctioning.

The idle speed is adjusted with idle speed adjusting screw 1. The idle mixture is adjusted with the idle mixture adjustment screw 2.

12.4 Carburetor - adjusting idle speed

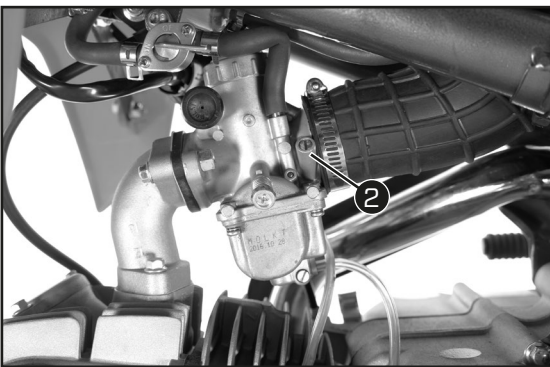

- Screw in the idle adjusting screw 2 until it stops and then to the prescribed basic setting.

Guideline

Idle mixture adjusting screw : Open 1 turn

- Run the engine until warm.

Guideline

Warming-up phase \geq 5 min

Danger d'intoxication

Exhaust gases are toxic and inhaling them may result in unconsciousness and death.

- ☞ Always make sure there is sufficient ventilation when running the engine.
- ☞ Use an effective exhaust extraction system when starting or running the engine in an enclosed space.

- Adjust the idle speed using the idle speed adjusting screw 1.

Guideline

Choke function deactivated - Push the choke lever up all the way to the stop > Pull the choke all the way to the stop.

Idle speed 1,400... 1,500 rpm

- Turn the idle adjusting screw 2 slowly clockwise until the idle speed begins to fall.
- Note the position and turn the idle adjusting screw slowly counterclockwise until the idle speed falls.
- Adjust to the point between these two positions with the highest idle speed.



If the speed rise is too high, reduce the idle speed to a normal level and repeat the preceding steps.

If the procedure described here does not lead to satisfactory results, the cause may be a wrongly dimensioned idling jet.

If you can turn the idle adjusting screw to the end without any change of engine speed, you have to install a smaller idling jet.

After changing the idling jet, start from the beginning with the adjusting steps.

Following extreme air temperature or altitude changes, adjust the idle speed again.

12.5 Checking the basic position of the shift lever



When driving, the shift lever must not touch the rider's boot when in the basic position. When the shift lever keeps touching the boot, the transmission will be subject to an excessive load.

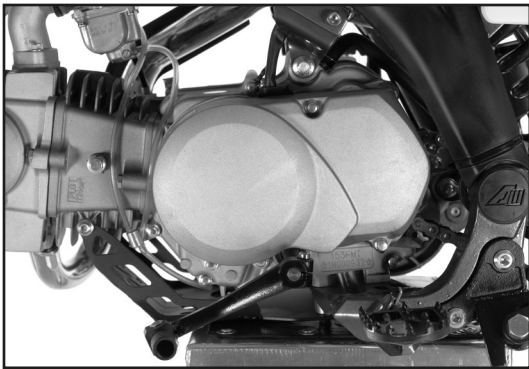

Sit on the vehicle in the riding position and determine distance A between the upper edge of your boot and the shift lever.

Distance between shift lever and upper edge of boot
10... 20 mm (0.39... 0.79 in)

If the distance does not meet specifications:

- Adjust the basic position of the shift lever. (📖.77)

12.6 Adjusting the basic position of the shift lever

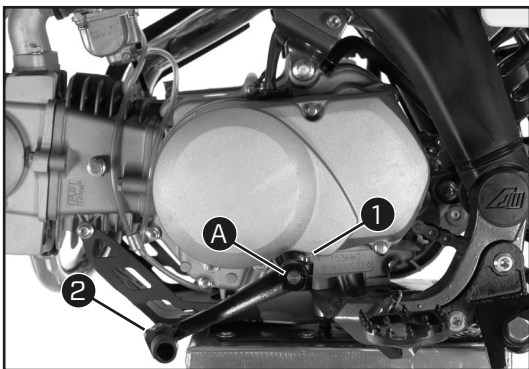

- Remove screw 1 with washers and take off shift lever 2.
- Clean gear teeth A of the shift lever and shift shaft.
- Mount the shift lever on the shift shaft in the required position and engage the gearing.



The range of adjustment is limited.

The shift lever must not come into contact with any other vehicle components during the shift procedure.

- Mount and tighten screw 1 with the washers.

Guideline

Screw, shift lever M6 5 Nm (3,6 lbf ft)

12.7 Checking the engine oil level



The engine oil level can be checked when the engine is cold or warm.



Preparatory work

- Stand the motorcycle upright on a horizontal surface.

Condition

The engine is cold.

- Check the engine oil level.

The engine oil reaches the middle of oil gauge or oil sight.

If the engine oil does not reach the middle of the level viewer:

- Add engine oil. (📖.80)

Condition

The engine is at operating temperature.

- Check the engine oil level.



After switching off the engine, wait one minute before checking the level.

12.8 Changing the engine oil and oil filter, cleaning the oil screens



Danger of scalding

Engine and gear oil get very hot when the motorcycle is ridden.

- Wear suitable protective clothing and safety gloves.
- In the event of scalding, rinse the area affected immediately with lukewarm water.



Danger pour l'environnement

Hazardous substances cause environmental damage.

- Dispose of oils, grease, filters, fuel, cleaning agents, brake fluid, etc., correctly and in compliance with the applicable regulations



Drain the engine oil while the engine is at operating temperature.



Preparatory work

- Park the motorcycle on a level surface.

Main work

- Place a suitable container under the engine.
- Remove oil drain plug 1 with the magnet and seal ring.
- Mount and tighten oil drain plug 1 with the magnet.

Guideline

Oil drain plug with magnet M12x1,5 20 Nm (14,8 lbf ft)

The 125cc and 140cc engines don't have oil filters.

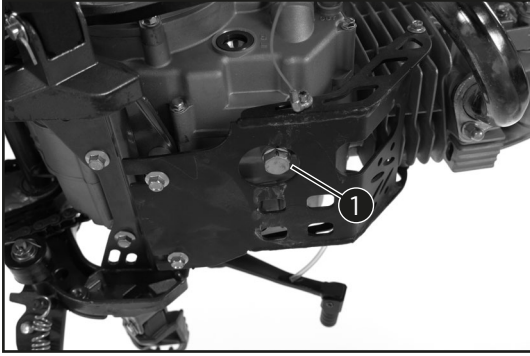

- Remove screws 2.
- Remove the oil filter cover with the O-ring..

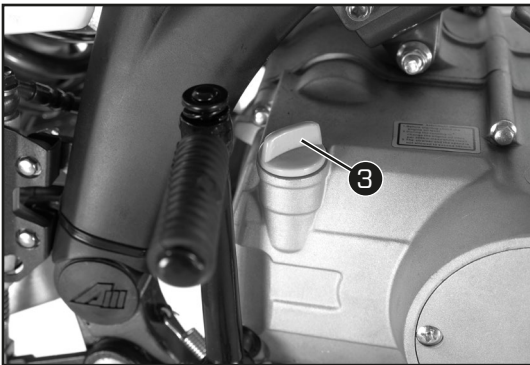

- Pull oil filter out of the oil filter housing.
- Completely drain the engine oil.
- Thoroughly clean the parts and sealing surfaces.
- Lay the motorcycle on its side and fill the oil filter housing to about 3/4 full with engine oil.
- Fill the oil filter with engine oil and position the oil filter in the housing.
- Mount and tighten the screws.

Guideline

Engine Oil (📖.89)

- Stand the motorcycle upright.
- Remove filler plug 8 with the O-ring from the clutch cover and fill up with engine oil.



Too little engine oil or poor-quality engine oil results in premature wear of the engine.

Install and tighten the oil filler plug with O-ring.

Danger d'intoxication

Exhaust gases are toxic and inhaling them may result in unconsciousness and death.

- ☞ Always make sure there is sufficient ventilation when running the engine.
- ☞ Use an effective exhaust extraction system when starting or running the engine in an enclosed space.
- ☞ Start the engine and check that it is oil-tight. Finishing work
- ☞ Check the engine oil level. (📖 .78)

12.9 Adding engine oil



Too little engine oil or poor-quality engine oil results in premature wear of the engine.



- Remove oil filler plug 1 with the O-ring from the clutch cover.
- Add the same engine oil used when the last oil change was carried out.

Engine oil (📖 .89)



For optimal performance of the engine oil, do not mix different types of engine oil.

We recommended changing the engine oil when necessary.

- Install and tighten the oil filler plug with O-ring.
- Monter le bouchon de remplissage avec son joint torique et le serrer.

Danger d'intoxication

Exhaust gases are toxic and inhaling them may result in unconsciousness and death.

- ☞ Always make sure there is sufficient ventilation when running the engine.
- ☞ Use an effective exhaust extraction system when starting or running the engine in an enclosed space.
- ☞ Start the engine and check that it is oil-tight.

13.1 Removing the battery



Risk of injur

Batteries contain harmful substances

- Keep batteries out of the reach of children.
- Keep sparks and open flames away from the batteries.
- Only charge batteries in well-ventilated rooms.
- Maintain a minimum clearance from inflammable materials when charging batteries. Minimum clearance 1 m (3 ft)
- Do not charge deeply discharged batteries if charge is already below the minimum voltage. Minimum voltage before the start of the charge 9 V

Preparatory work

- Switch off all power consumers and switch off the engine.
- Remove the seat. (.67)

Main work

- Cable 1 from the battery.
- Pull back the red positive terminal cover 2 and disconnect the positive cable from the battery.
- Pull back the elastic and remove battery toward the top.

13.2 Installing the battery

Main work

- Insert the battery into the battery compartment with the terminals facing forward and secure with holding bracket.
- Connect the red positive cable to the battery.

Guideline

Screw, battery terminal M5 2.5 Nm (1.84 lbf ft)

- Connect the black negative cable to the battery.

Guideline

Screw, battery terminal M5 2.5 Nm (1.84 lbf ft)

// 14. CLEANING, CARE

14.1 Cleaning the motorcycle



Material damage

Components become damaged or destroyed if a pressure cleaner is used incorrectly.

The high pressure forces water into the electrical components, connectors, throttle cables, and bearings, etc.

Pressure which is too high causes malfunctions and destroys components.

- Do not direct the water jet directly on to electrical components, connectors, throttle cables or bearings.

- Maintain a minimum distance between the nozzle of the pressure cleaner and the component.

Minimum clearance 60 cm (23.6 in)



Environmental hazard

Hazardous substances cause environmental damage.

- Dispose of oils, grease, filters, fuel, cleaning agents, brake fluid, etc., correctly and in compliance with the applicable regulations.



If you clean the motorcycle regularly, its value and appearance will be maintained over a long period. Avoid direct sunshine on the motorcycle during cleaning.

- Close off the exhaust system to prevent water from entering.
- First remove coarse dirt particles with a gentle spray of water.
- Spray very dirty areas with a normal motorcycle cleaner and then clean with a paintbrush.



Use warm water containing normal motorcycle cleaner and a soft sponge. Never apply motorcycle cleaner to the dry vehicle; always rinse with water first.

- After rinsing the motorcycle with a gentle spray of water, allow it to dry thoroughly.
- Remove the plug from the exhaust system.



Danger of accidents

Moisture and dirt impair the brake system.

- Brake carefully several times to dry out and remove dirt from the brake linings and the brake discs.
- After cleaning, ride a short distance until the engine reaches operating temperature.









The heat produced causes water at inaccessible locations in the engine and the brake system to evaporate.

- Push back the protection caps of the handlebar controls to allow any water that has penetrated to evaporate.
- After the motorcycle has cooled off, lubricate all moving parts and bearings.
- Clean the chain.
- Treat bare metal parts (except for brake discs and the exhaust system) with a corrosion inhibitor.

15.1 Bike Storage

Danger of poisoning

Fuel is poisonous and a health hazard.





-  Avoid skin, eye and clothing contact with fuel.
-  Immediately consult a doctor if you swallow fuel.
-  Do not inhale fuel vapors.
-  In case of skin contact, rinse the affected area with plenty of water.
-  Rinse the eyes thoroughly with water, and consult a doctor in case of fuel contact with the eyes.
-  Change your clothing in case of fuel spills on them.
-  Keep fuels correctly in a suitable canister, and out of the reach of children.



If you plan to garage the motorcycle for a longer period, perform the following steps or have them performed.

Before storing the motorcycle, check all parts for function and wear. If service, repairs, or replacements are necessary, you should do this during the storage period (less workshop overload). In this way, you can avoid long workshop waiting times at the start of the new season.

When refueling for the last time before taking the motorcycle out of service, add fuel additive.

- Refuel. ( .40)
- Clean the motorcycle. ( .82)
- Change the engine oil and oil filter and clean the oil screens. ( .78)
- Check the tire air pressure. ( .57)
- Remove the battery. ( .81)
- Recharge the battery.

Guideline

Storage temperature of battery without direct sunshine 0... 35 °C (32... 95 °F)

- Store the vehicle in a dry location that is not subject to large fluctuations in temperature.



Do not use non-porous materials since they prevent humidity from escaping, thus causing corrosion.

Avoid running the engine for a short time only. Since the engine cannot warm up properly, the water vapor produced during combustion condenses and causes valves and the exhaust system to rust.

Apollo recommends jacking up the motorcycle.

- Raise the motorcycle with a lift stand.
- Cover the vehicle with a tarp or similar cover that is permeable to air.

// 16. TROUBLESHOOTING

Faults	Possible cause	Action
Engine turns but does not start	Spark plug oily or wet	Clean and dry the spark plug, or change it if necessary.
	Short circuit cable in wiring harness frayed, kill switch defective, fault in ignition system	Check the wiring harness. (visual check) Check the electrical system: -CDI -Coil -Rotor
	Water in carburetor or jets blocked	Check/set the carburetor components.
	Motorcycle was out of use for a long time and there is old fuel in the float chamber	Empty the carburetor float chamber.
	Valve clearance too little	- Adjust the valve clearance.
The engine does not turn when the starter button is pressed	Battery is discharged	Recharge the battery. Check the charging voltage. Check the open-circuit current. Check the stator winding of the alternator.
	Main fuse blown	Change the main fuse.
	Starter relay defective	Check the starter relay.
	Starter motor defective	Check the starter motor.
Engine has no idle	Idling jet blocked	Check/set the carburetor components.
	Adjusting screws on the carburetor are in turned to the wrong position	Carburetor - adjust the idle speed (11.76).
	Spark plug defective	Change spark plug.
	Ignition system defective	Check the ignition coil. Check the spark plug connector.
Engine does not speed up	The carburetor is flowing over because the float needle is dirty or worn	Check/set the carburetor components.
	Loose carburetor jets	Check/set the carburetor components.
	Fault in ignition system	Check the ignition system.
Engine has too little power	Fuel supply interrupted	Check the fuel tank breather. Clean the fuel tap. Check/set the carburetor components.
	Air filter very dirty	Clean the air filter and air filter box.
	Exhaust system leaky, deformed or too little glass fiber yarn filling in main silencer	Check exhaust system for damage. Change the glass fiber yarn filling of the main silencer.
	Ignition system defective	Check the ignition coil. Check the spark plug connector.
	Noticeable wear	Overhaul the engine.
	Clutch engagement speed too low or too high	Check the clutch setting.
	Valve clearance too little	Adjust the valve clearance.
Engine stalls or is popping into the carburetor	Lack of fuel	Fill up with fuel. (11.40)
	Engine takes in bad air	Check the intake flange and carburetor for tightness
	The connector or ignition coil is loose or oxidized	Clean the plug-in connection and treat it with contact spray.
White smoke emission (steam in exhaust gas)	Damaged cylinder head or cylinder head gasket	Check the cylinder head or cylinder head gasket.
Battery is discharged	Battery is not charging	Check the charging voltage. Check the stator winding of the alternator.
	Unwanted power consumer	Check the open-circuit current.

// 17. TECHNICAL DATA

17.1 ENGINE

17.1.1 FREERIDE 125

Type	Moteur à essence monocylindre à 4 temps
Design	1-cylinder 4-stroke engine
Displacement	119.6ml
Stroke	55,5
Bore	52,4
Compression	9.3:1
Valve diameter, intake	27mm
Valve diameter, exhaust	23mm
Admission à : 20 °C (68 °F)	
Intake at: 20 °C (68 °F)	0.03-0.05mm
Exhaust at: 20 °C (68 °F)	0.05-0.07mm
Crankshaft bearing	2 cylinder roller bearing
Piston	Aluminum cast
Clutch	Multidisc clutch in oil bath
Gearbox	4-gear N-1-2-3-4
Transmission ratio	
1re vitesse	3,272
2e vitesse	1,937
3e vitesse	1,35
4e vitesse	1,043
Spark plug	NGK CR7HSA
Starting aid	Kick

17.1.2 FREERIDE 140

Type	Moteur à essence monocylindre à 4 temps
Design	1-cylinder 4-stroke engine
Displacement	140ml
Stroke	57
Bore	56
Compression	9.8:1
Valve diameter, intake	27mm
Valve diameter, exhaust	23mm
Valve clearance	
Intake at: 20 °C (68 °F)	0.03-0.05mm
Exhaust at: 20 °C (68 °F)	0.05-0.07mm
Crankshaft bearing	2 cylinder roller bearing
Piston	Aluminum cast
Clutch	Multidisc clutch in oil bath
Gearbox	4-gear N-1-2-3-4
Transmission ratio	
1re vitesse	3,272
2e vitesse	1,937
3e vitesse	1,35
4e vitesse	1,043
Spark plug	NGK CR7HSA
Starting aid	Kick

17.1.3 FREERIDE 150

Type	Moteur à essence monocylindre à 4 temps
Design	1-cylinder 4-stroke engine
Displacement	147.8ml
Stroke	60
Bore	56
Compression	9.9:1
Valve diameter, intake	27mm
Valve diameter, exhaust	23mm
Valve clearance	
Intake at: 20 °C (68 °F)	0.03-0.05mm
Exhaust at: 20 °C (68 °F)	0.05-0.07mm
Crankshaft bearing	2 cylinder roller bearing
Piston	Aluminum cast
Clutch	Multidisc clutch in oil bath
Gearbox	4-gear N-1-2-3-4
Transmission ratio	
1re vitesse	3,272
2e vitesse	1,937
3e vitesse	1,35
4e vitesse	1,043
Spark plug	NGK CR7HSA
Starting aid	Kick

17.1.4 FREERIDE S 190

Type	Moteur à essence monocylindre à 4 temps
Design	1-cylinder 4-stroke engine
Displacement	187.2ml
Stroke	62
Bore	62
Compression	(10.6-11.3):1(10.6-11.3):1
Valve diameter, intake	30mm
Valve diameter, exhaust	26mm
Valve clearance	
Intake at: 20 °C (68 °F)	0.05-0.07 mm
Exhaust at: 20 °C (68 °F)	0.05-0.07 mm
Crankshaft bearing	2 cylinder roller bearing
Piston	Aluminum cast
Clutch	Multidisc clutch in oil bath
Gearbox	5-gear 1-N-2-3-4-5
Transmission ratio	
1re vitesse	2,429
2e vitesse	1,733
3e vitesse	1,33
4e vitesse	1,091
Spark plug	0,917
Starting aid	Electric starter

17.2 Carburetor settings

17.2.1 FREERIDE 125

Carburetor type	MOLKT C26(125CC)
Needle position	3/5 position from top
Idle mixture adjusting screw	1 circle back from right limiting position
Main jet	98#
Idling jet	38#
Throttle slide	Φ2.473

17.2.2 FREERIDE 140

Carburetor type	MOLKT C26(140CC)
Needle position	3/5 position from top
Idle mixture adjusting screw	1 circle back from right limiting position
Main jet	98#
Idling jet	35#
Throttle slide	Φ2.473

17.2.3 FREERIDE 150

Carburetor type	MOLKT C26(149CC)
Needle position	3/5 position from top
Idle mixture adjusting screw	1 circle back from right limiting position
Main jet	95#
Idling jet	38#
Throttle slide	Φ2.473

17.2.4 ELITE S 190

Carburetor type	MOLKT PE28
Needle position	3/5 position from top
Idle mixture adjusting screw	1 circle back from right limiting position
Main jet	118#
Idling jet	40#
Throttle slide	Φ3.0

17.1 Capacities

17.2.1 Engine Oil

FREERIDE 125	0.9L	SAE 10W40
FREERIDE 140	0.9L	SAE 10W40
FREERIDE 150	0.9L	SAE 10W50 / SAE 15W50
FREERIDE S 190	1.1L	SAE 10W50 / SAE 15W50

17.3.1 Fuel

Total fuel tank capacity, approx.	6,5L
-----------------------------------	------

17.4 Chassis

Frame	Cadre tubulaire central en acier
Fork (FREERIDE 125/140/150)	VOLT SUSPENSION V-ONE 33 810mm
Fork (FREERIDE S 190)	VOLT SUSPENSION V-TRAAK 37 810mm
Front suspension travel	210mm
Shock absorber (FREERIDE 125/140/150)	VOLT SUSPENSION V-ONE 350mm
Shock absorber (FREERIDE S 190)	VOLT SUSPENSION V-FORCE 350mm
Shock absorber (FREERIDE S 190 option)	VOLT SUSPENSION V-TRAAK 350mm
Rear suspension travel	58mm
Brake system	Freins à disques, étriers de frein flottants
Diamètre des disques de frein	
Front	220 mm
rear	190 mm
Brake discs - wear limit	2.2 mm (0.087 in)
Tire air pressure off road	1,0 bar (15 psi)
Secondary ratio	
Chain	KMC 428
Rear sprockets available	37,39,41,43,45
Steering head angle	24°
Wheelbase	1300±10 mm
Ground clearance, unloaded (wheels 14"/17")	350mm
Ground clearance, unloaded (wheels 16"/19")	370mm
Seat height, unloaded	845mm
Weight without fuel, approx.	77 kg
Maximum permissible	100kg

17.5 Tires

Front	60/100-17 or 60/100-19
Rear	80/100-14 or 80/100-16

NOTES:

NOTES:

NOTES:

